

# The Journal of Laryngology and Otology

EDITED BY  
G. H. BATEMAN

ASSISTANT EDITOR  
LIONEL TAYLOR

## Contents

Electro-Nystagmography . . . . .	J. D. HOOD	167 ✓
The Chick Embryo Otocyst in Tissue Culture: A Model Ear . . . . .	I. FRIEDMANN	185
A Survey of over 1,000 School Leavers who have had Their Tonsils Removed . . . . .	T. M. BANHAM	203 ✓
Globus Hystericus Vel Pharyngis (A Reconnaissance of Proximal Vagal Modalities) . . . . .	KENNETH G. MALCOMSON	219
On the Treatment of Vascular Insufficiencies of the Labyrinth with Thymoxamine . . . . .	N. W. GILL	231
Clinical Records—		
Ectopic Salivary Tissue in Relation to the Tonsil . . . . .	LEWIS LABIB SAMY, ISKANDER H. GIRGIS and SHAFIK A. WASEF	247
Spontaneous Evacuation of Salivary Calculus . . . . .	G. J. CONRAD	255
Oncocytoma of the Accessory Salivary Glands . . . . .	M. JALISI	257
Haemangiopericytoma of the Gum . . . . .	R. E. REWELL	261
Nasal Polyposis in Cystic Fibrosis . . . . .	G. A. TOMA and G. E. STEIN	265 ✓
Osteoma of the Tongue . . . . .	WILLIAM H. KAYE	269 ✓
Osteoma of the Tongue . . . . .	V. JAHNKE and J. F. DALY	273 ✓
General Notes		

## Headley Brothers Ltd

Ashford, Kent

Annual Subscription £5/5/0 net, U.S.A. \$15

Monthly, 12/6 net post free

# The Journal of Laryngology and Otology

(FOUNDED IN 1887 BY MORELL MACKENZIE AND NORRIS WOLFENDEN)

EDITED BY  
G. H. BATEMAN

ASSISTANT EDITOR  
LIONEL TAYLOR

1. Original articles which have not been published elsewhere are invited and should be sent to the Editor. They are considered for publication on the understanding that they are contributed to this *Journal* solely. Reproduction elsewhere, in whole or in part, is not permitted without the previous written consent of the Author and Editor and the customary acknowledgment must be made.

2. Manuscripts should be typewritten, on one side only of the paper, and well spaced. Captions to illustrations should be typed on a separate sheet and sent at the same time as original photographs, etc.

The Harvard system of recording references should be used, e.g. GREEN, C., and BROWN, D. (1951) *J. Laryng.*, 65, 33. Abbreviations of Journals should follow the style recommended in *World Medical Periodicals*, published by World Health Organization, 1952.

It is most important that authors should verify *personally* the accuracy of every reference before submitting a paper for publication.

3. Galley proofs and engraver's proofs of illustrations are sent to the author. Corrections, which should be kept to a minimum, must be clearly marked, and no extra matter added. Proofs should be returned within 5 days.

4. Illustration blocks will normally be held by the Printers for three years, after which they will be destroyed. Any author is entitled to have these returned to him, but a request for this must be sent within three years of the appearance of the article, to HEADLEY BROTHERS LTD., The Invicta Press, Ashford, Kent. Coloured illustrations will be charged to authors, unless a special grant is authorized by the Editor.

5. Orders for reprints must be sent when returning galley proofs, and for this purpose special forms are supplied.

6. Editorial communications may be addressed to THE EDITOR, *Journal of Laryngology*, c/o HEADLEY BROTHERS LTD., The Invicta Press, Ashford, Kent.

7. The annual subscription is five guineas sterling (U.S.A. \$15) post free, and payable in advance.

8. Single copies will be on sale at 12s. 6d. each; copies of parts up to Vol. LXIII which are available may be purchased at 7s. 6d. each.

9. All subscriptions, advertising and business communications should be sent to the publishers, HEADLEY BROTHERS LTD., The Invicta Press, Ashford, Kent.

## United States of America

Orders for this *Journal* may be sent through local booksellers, or to STECHERT-HAPNER, INC., 31-33 East 10th Street, New York, or direct to the publishers, HEADLEY BROTHERS LTD., The Invicta Press, Ashford, Kent, England.

© *Journal of Laryngology and Otology*, 1968

# LARYNGOSTROBOSCOPE

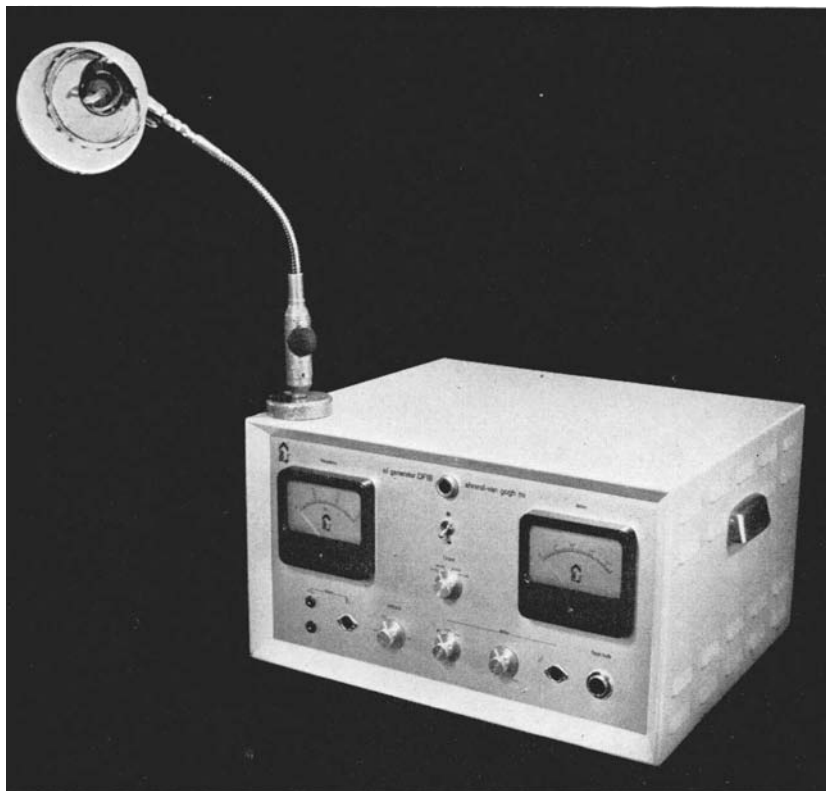

The Ahrend Van Gogh Laryngostroboscope ( $\Delta$  F Generator) shows the vibration of the vocal chords slowed down to about one cycle per second. It is also possible to stop the movement by stroboscopic effect and then tune through all phases of one cycle.

A cine camera adaptor can also be supplied enabling normal speed cine shots to be taken.

For further details write or phone:

**T.E.M. SALES LIMITED**

GATWICK ROAD CRAWLEY SUSSEX

Telephone: Crawley 23332

*Sales and Service Agents for Ahrend Van Gogh in the United Kingdom*

Please mention *The Journal of Laryngology and Otology* when replying to advertisements

**FROM  
THE  
FRONT**

*...and with A.V.C. where required*



—that is the triumph of the  
**MACKIE**  
hearing aid

The new Mackie post-aural hearing aid is made in several different circuit versions so that the gain and frequency response can be selected to match the patient's needs; and it is available where required with a unique form of automatic volume control which has proved highly successful in cases of recruitment. The forward pick-up microphone gives maximum

intelligibility of speech without background interference.

It is exported to many countries including the United States of America—a tribute to its high quality and advanced design.

In Great Britain it is available for trial by your patients from *independent* hearing aid dealers in all parts of the country.

MANUFACTURED BY A. G. R. MACKIE LTD. A member of the Bonochord Group of Companies  
FOR FURTHER DETAILS WRITE TO 48 WELBECK STREET, LONDON W1

Please mention *The Journal of Laryngology and Otology* when replying to advertisements

***WHEN A HEARING AID  
IS RECOMMENDED  
ONLY AMPLIVOX  
OFFERS THIS  
HEARING AID SERVICE***

The design and manufacture of a complete range with individual fitting facilities.

Best of other makes in addition to Amplivox aids—Amplivox hearing aids are ONLY available from Amplivox.

Highest degree of training of any hearing aid organisation.

Master Hearing Aid evaluations.

Expert follow-up and rehabilitation advice.

14 branch offices with while-you-wait service.

**FOR YOUR PATIENTS' GREATEST SATISFACTION  
SPECIFY AMPLIVOX**

**AMPLIVOX**

World's most experienced and complete hearing service

**AMPLIVOX HEARING ADVISORY SERVICE**

**80 NEW BOND STREET**

**LONDON, W.1**

**TEL : 01-493 9888**

Please mention *The Journal of Laryngology and Otology* when replying to advertisements

*Refer your patients to*

# Ingrams

INDEPENDENT HEARING AID SUPPLIERS

*Ingrams have the  
different makes  
to choose from*

**LONDON** 2 Shepherd Street, London, W.1. Hyde Park 9041  
*(2 minutes from Green Park)*

**BIRMINGHAM** 20 Auchinleck Sq, Broad St, Birmingham, 15. Midland 4314  
*(In the Five Ways Shopping Centre)*

**BRIGHTON** 5 Duke Street, Brighton, 1. Brighton 28699  
*(First turning off West Street)*

**CROYDON** 11 Essex House, College Road, Croydon. Croydon 4663  
*(Opposite the Technical College)*

**MANCHESTER** Peter House, St. Peter's Sq, Manchester, 1. Central 5711  
*(Near the Midland Hotel)*

**...and in SCOTLAND it's BONOCHORD-INGRAMS...**

**ABERDEEN** 461, Union Street, Aberdeen. Aberdeen 29632  
*(Near Holborn Junction)*

**EDINBURGH** 17, Stafford Street, Edinburgh. Caledonian 1942  
*(Corner of Alva Street)*

**GLASGOW** 38 Bath Street, Glasgow, C.2. Douglas 7710  
*(Next door to Glasgow Corporation Transport Office)*

Domiciliary visits in EVERY part of the country.

INGRAMS FOR THE LARGER RANGE OF HEARING AIDS—

Subscribers to the Code of Ethics of the Hearing Aid Industry Association.

Please mention *The Journal of Laryngology and Otology* when replying to advertisements

# AMPLIVOX

FOR CLINICAL AUDIOMETRY

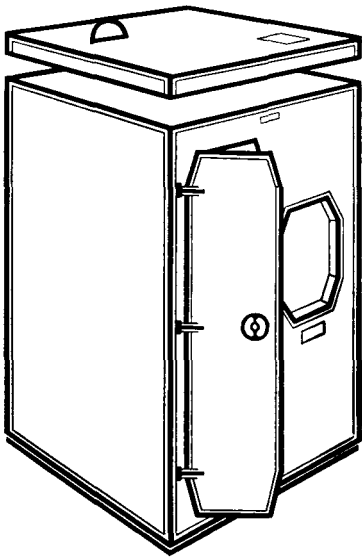

**Audiometer Booths**  
 prefabricated to ensure correct acoustic environment for threshold audiometry, research, etc. Available in standard and special sizes.

**Manual Audiometers**  
 with narrow band masking for highest accuracy and extended resolution. Battery-operated transistor models also available.

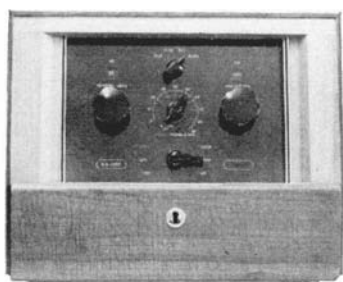

**Automatic Audiometers**  
 As exclusive U.K. distributors, we are able to offer Rudmose Self-Recording Audiometers from the most simple to the most comprehensive Diagnostic Békésy Audiometer illustrated.



**Calibration Service, Screening, Speech & Industrial Audiometers**  
 Please write for technical literature to meet your needs

**AMPLIVOX**  
 HEARING ADVISORY SERVICE LTD  
 80 New Bond St, London, W1 Tel: 01-493 9888

Please mention *The Journal of Laryngology and Otology* when replying to advertisements

# PETERS AP/5 CLINIC AUDIOMETER

WITH SYNCHRONOUS MASKING

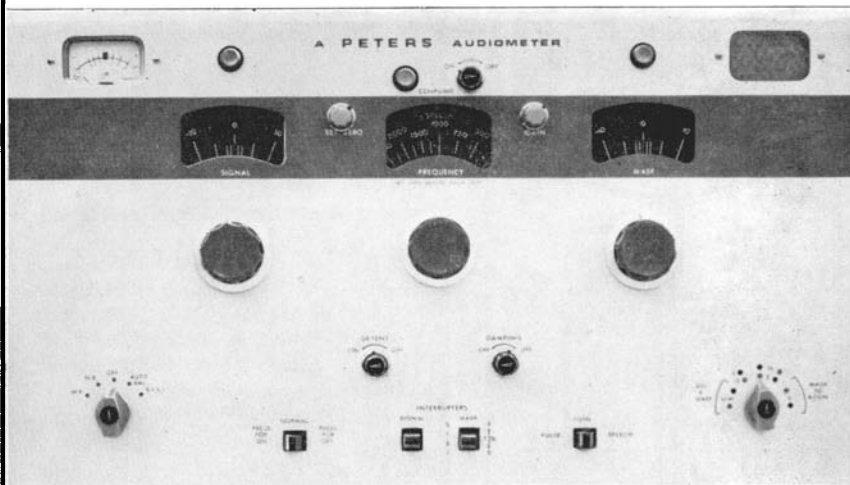

This new clinic audiometer of very advanced design offers:

- A continuous frequency range with continuously variable attenuation accurate and readable to less than 1 db.
- Synchronous masking. A new, accurate and speedier masking technique, which is semi-automatic.
- Narrow band masking for pure-tone measurements and white noise for speech.
- Automatic loudness balance switching.
- The SISI Test, the Rainville B.C. Test, automatic pulsing.
- Full speech facilities.
- Interchangeable slide and plug in sub-chassis.
- Operator checks of output and threshold.

Five additional features are offered by the still more advanced  
**PETERS AP/6 CLINIC AUDIOMETER**

Both audiometers can be used with the "PETERS" automatic  
**BÉKÉSY ACCESSORY**

write for full details to:

**ALFRED PETERS AND SONS LTD**  
 GELL STREET SHEFFIELD 3

Please mention *The Journal of Laryngology and Otology* when replying to advertisements



Just one of the reasons why Ceporin has  
an important place in the ENT unit

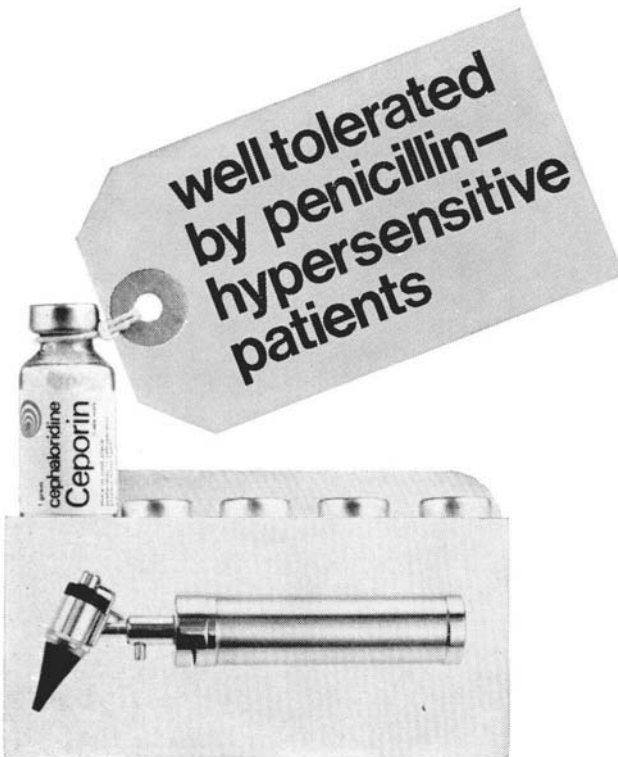

Please mention *The Journal of Laryngology and Otology* when replying to advertisements

# Ceporin

 cephaloridine**Broad spectrum**

Ceporin is highly active against most gram-positive organisms—including penicillin-resistant staphylococci—and many gram-negative organisms.

**Bactericidal**

Ceporin rapidly kills susceptible organisms at or near the minimum inhibitory concentration, leaving little opportunity for resistance to develop.

**Well tolerated**

Ceporin has very low toxicity and can be given safely to the newborn.<sup>1</sup> In reduced dosage, Ceporin is safe to use when renal function is impaired<sup>2</sup> and is usually well tolerated by patients allergic to penicillin.<sup>3</sup>

**Clinical success**

"The claims of cephaloridine rest on its very broad range of bactericidal activity and upon its low toxicity, particularly in patients who have shown hypersensitization to penicillin."<sup>4</sup>

Many published conclusions such as this have confirmed the value of Ceporin in the treatment of patients in whom penicillin has proved ineffective or dangerous. Ceporin's broad-spectrum activity is particularly useful when mixed infections are encountered—as, for example, in sinusitis.

**New 100 mg vials for babies**

For greater convenience in the preparation and administration of small doses, Ceporin is now presented in vials containing 100 mg of cephaloridine. In the usual recommended dosage for infants, 100 mg will be used all at once without waste.

**References**

1. Supplement to *Postgrad. med. J.* (1967) **43**, 105, 112.
2. Supplement to *Postgrad. med. J.* (1967) **43**, 87, 92.
3. *Amer. J. med. Sci.* (1966) **251**, 275.
4. *Brit. J. Clin. Pract.* (1967) **21**, 335.

Please mention *The Journal of Laryngology and Otology* when replying to advertisements

**For your detailed reading  
Ceporin cephaloridine**

Ceporin is cephaloridine, a semi-synthetic, broad-spectrum, bactericidal antibiotic derived from cephalosporin C, presented as a water-soluble crystalline powder for parenteral administration in solution. It is usually well tolerated by patients who are allergic to penicillin.

**Antibacterial activity**

Ceporin is highly active against *Staphylococcus aureus* including strains which are resistant to penicillin, *Streptococcus pyogenes*, *Streptococcus viridans*, *Diplococcus pneumoniae*, *Corynebacterium diphtheriae*, *Bacillus anthracis*, Clostridia spp. and some strains of *Streptococcus faecalis* (enterococcus). Gram-negative organisms which are sensitive to Ceporin include *Proteus mirabilis* (the commonest infecting organism of the *Proteus* species), *Escherichia coli*, *Neisseria meningitidis*, *Neisseria gonorrhoea*, most strains of *Klebsiella pneumoniae*, and many strains of *Haemophilus influenzae*. Ceporin is also active against *Treponema* and *Leptospira* spp. It has no activity clinically against *Pseudomonas aeruginosa* (*pyocyanea*), *Mycobacterium tuberculosis*, *Brucella abortus*, most strains of *Aerobacter aerogenes*, pathogenic fungi, protozoa or viruses. Ceporin is highly bactericidal. Like the penicillins it acts principally against actively growing and dividing cells, of which usually more than 99% are killed in two to five hours, at concentrations only slightly higher than the minimum inhibitory concentration. Development of resistance is therefore uncommon. Ceporin is relatively insensitive to staphylococcal penicillinase.

**Indications:**

Respiratory tract infections: follicular tonsillitis,

pharyngitis, sinusitis, acute and chronic bronchitis, infected bronchiectasis, bacterial pneumonia and bronchopneumonia, post-operative chest infections, empyema, lung abscess and complicated whooping cough.  
Urinary tract infections: acute and chronic pyelonephritis, cystitis, asymptomatic bacteriuria and bacterial prostatitis. Soft-tissue and skin infections: furunculitis, cellulitis, carbuncles, abscesses, erysipelas, infected gangrene, otitis media and mastoiditis, peritonitis and post-traumatic and post-surgical wound infections.  
Other infections: septicaemia, whether gram-positive or gram-negative, Endocarditis, both acute and subacute. Meningitis, especially pneumococcal. Gynaecological and obstetrical infections, including septic abortion, uterine infections, endometritis, amnionitis, pelvic abscess, pelvic cellulitis, breast abscess and prophylactically in Caesarean section and prolonged labour. Neo-natal infection, prophylaxis and treatment. Gonorrhoea and syphilis where penicillin is unsuitable due to resistant organisms or allergy. Bone and joint infections, including osteomyelitis and septic arthritis. Intensive care, artificial kidney and peritoneal dialysis units—prophylactically and therapeutically. Prophylactically in open-heart, vascular and genito-urinary surgery. Also in orthopaedic surgery where amputations are undertaken because of inadequate blood supply to limbs.  
Dental treatment: patients receiving long-term penicillin prophylaxis against endocarditis require a different antibiotic whilst undergoing dental treatment and Ceporin is well suited for this purpose.  
**General dosage and administration**  
Ceporin is not absorbed by mouth. It is usually given by intramuscular or deep subcutaneous injection, which is painless and well tolerated. It may also be given intravenously, intrathecally, intrapleurally or intraperitoneally.

**Table 1 General guide to dosage (see also specific dosage recommendations section)**

Indications	Adults	Infants and children
Gram-positive infections of a mild or moderate nature* and urinary tract infections	15 to 30 mg/kg/day e.g. 0.5 gram two or three times a day or 1 gram twice a day 1 gram once a day is adequate	15 to 30 mg/kg/day (7 to 14 mg/lb/day) divided into two or three doses
*Acute, simple soft tissue infections		
Gram-negative or mixed infections (except those of the urinary tract) and severe gram-positive infections	40 to 66 mg/kg/day e.g. 1 gram three times a day or 1.5 grams two or three times a day or 2 grams twice a day	40 to 60 mg/kg/day (18 to 27 mg/lb/day) divided into two or three doses
Infections of exceptional severity (e.g., bacterial endocarditis and septicaemia) and severe, chronic, purulent bronchitis	60 to 100 mg/kg/day e.g. 1.5 to 2 grams three times a day or 1 gram four times a day	60 to 100 mg/kg/day (27 to 45 mg/lb/day) divided into two to four doses
Neo-natal infections therapy		30 mg/kg/day divided into two doses
prophylaxis		30 mg/kg/day as one daily dose

**General guide to dosage in presence of impaired renal function**

If renal function is impaired and the dosage of the drug not reduced, then abnormally high, and possibly toxic, levels of the drug may accumulate in the blood and tissues. The degree of renal function impairment should be determined (as, for example, by creatinine clearance,

serum creatinine and blood urea) and, if possible, blood levels of the antibiotic should be monitored. Table 2 is an approximate guide to continuation dosage, following a loading dose of 1 gram of Ceporin. Adjustment may be needed for individual patients according to the blood levels of drug achieved.  
(continued overleaf)

Please mention *The Journal of Laryngology and Otology* when replying to advertisements

Table 2

Blood urea mg/100 ml	Serum creatinine mg/100 ml	Creatinine clearance mg/min	Recommended maximum dosage of Ceporin grams daily
60 to 100	1.2 to 4	> 10	2.0
100 to 200	4 to 6	5 to 10	1.0
> 200	> 6	< 5	0.5

**Side effects and toxicity**

With a dosage of 6 grams or more daily, hyaline casts have appeared temporarily in the urine of some patients, occasionally accompanied by scanty other cellular elements. There have also been rare reports of disturbance of renal function associated with high blood levels of Ceporin. It is important, therefore, when using high doses of the drug (6 grams or more daily) or when renal function is impaired, to avoid abnormally high blood levels of Ceporin. Dosage should be adjusted carefully in patients with severe renal impairment in accordance with blood levels of the drug (see section on dosage recommendations for patients with impaired renal function). As with other antibiotics, Ceporin should be administered with caution to patients with a history of allergy, especially to drugs (including penicillin). Ceporin is usually tolerated well by patients allergic to penicillin, but cross-reaction with penicillin has been encountered rarely. Ceporin occasionally causes hypersensitivity reactions, mostly skin rashes. If this happens the drug should be stopped and not used again in that patient.

Very rarely an anaphylactic reaction has developed. In this event the drug should be discontinued immediately and the patient treated at once with the usual agents (adrenaline, antihistamines and an intravenous corticosteroid). A few cases of reversible neutropenia have been reported and a temporary slight rise in serum glutamic-oxaloacetic transaminase has been noted. Reversible nystagmus and signs of cerebral irritation have occurred following intrathecal administration of 100 mg or more, but not when the maximum adult intrathecal dose does not exceed 50 mg. There has been no laboratory or clinical evidence of teratogenicity or embryopathic effects but, as with all drugs, Ceporin should be used with caution in the early months of pregnancy.

**Presentation**

Ceporin is issued in vials containing 250 mg, 500 mg and 1 gram of cephaloridine, packed singly and in boxes of five. Vials containing 100 mg of cephaloridine are packed in boxes of five only.



Ceporin is a Glaxo  
trade mark

Detailed literature  
available on request



Glaxo Laboratories Ltd  
Greenford, Middlesex

Please mention *The Journal of Laryngology and Otology* when replying to advertisements

# GUSTOMETER

Anodal Galvanic Tongue Stimulator

An entirely new low cost instrument for the objective assessment of **TASTE SENSITIVITY** in facial paralysis and other conditions

Invaluable to otolaryngologists

Price £47

Full information from  
**BEAUMARIS ELECTRONICS LTD**  
 Beaumaris, Anglesey

Telephone 469

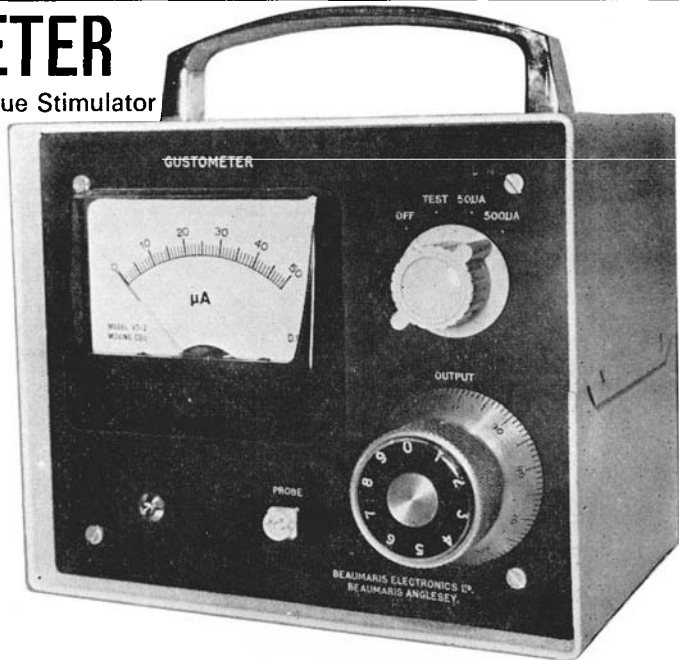

## THE LARYNGOSCOPE

A Monthly Journal  
 devoted to the disease of  
**EAR, NOSE AND THROAT**

*Official organ for the American Laryngological  
 Rhinological and Otological Society*

Price \$18.00 per year      Canada \$19.00 per year  
 Foreign \$19.00 per year

ESTABLISHED 1896

THEODORE E. WALSH, M.D.  
 EDITOR

517 SOUTH EUCLID AVENUE  
 SAINT LOUIS MO. 63110.

Please mention *The Journal of Laryngology and Otology* when replying to advertisements

# He's focusing a microscope... while performing delicate surgery.

New fully motorized Zeiss Operation Microscope II has foot-operated panel to control height adjustment and zoom action.

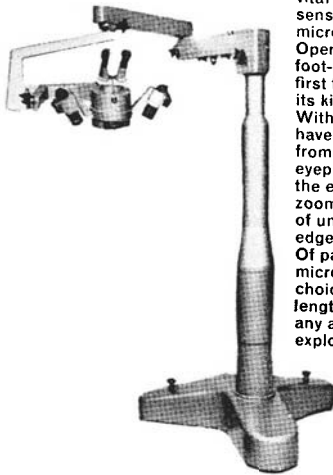
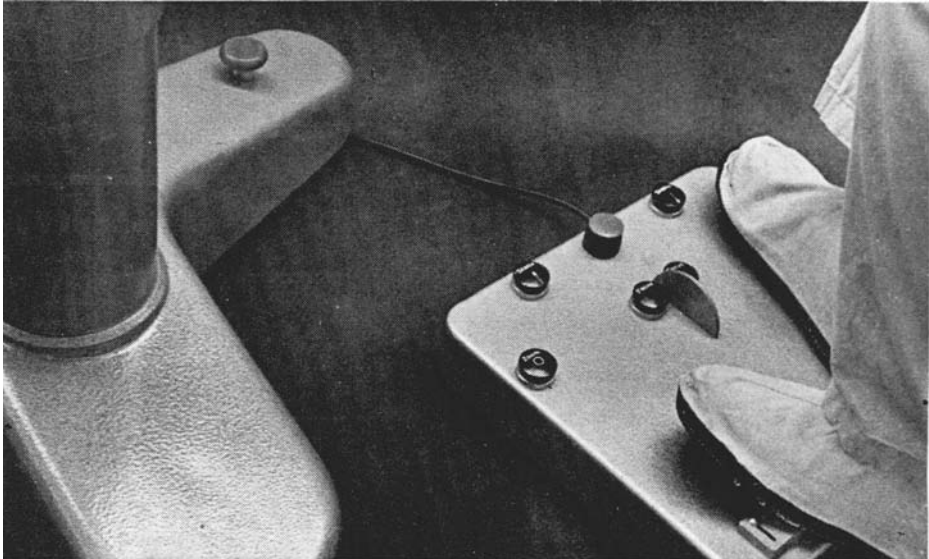

Freeing the surgeon's hands for his vital work is such obvious good sense. Yet, only one operation microscope does it—the new Zeiss Operation Microscope II with foot-operated control panel. It's the first fully motorized instrument of its kind.

With motorized zoom optics, you have a choice of any magnification from 2.5 to 53x . . . depending on eyepieces and objective. Throughout the entire range, this unique new zoom system provides a stereo image of unequalled brightness and edge-to-edge sharpness.

Of particular interest in microsurgery is the wide choice of objectives of different focal lengths which allow observation of any area the surgeon wishes to explore.

The swivel-arm arrangement permits setting of the microscope to any desired position.

For deep fissures, a high-intensity coaxial internal illuminator provides bright light. Two additional rotatable, external illuminators give maximum contrast and eliminate glare.

An adaptor accepts two binocular tubes so that a second physician can observe exactly the same field stereoscopically. Further, the Zeiss Beam Splitter accommodates monocular observation tubes for two additional observers; for attachment of a photo adaptor for regular, stereo, cine photography, or TV.

Power supply, wiring and connectors are built into the instrument's elegant, modern stand.

Full details from Carl Zeiss at Degenhardt & Co Ltd 20/22 Mortimer Street London W1 01-636 8050 (15 lines)

# ZEISS



West Germany



Please mention *The Journal of Laryngology and Otology* when replying to advertisements

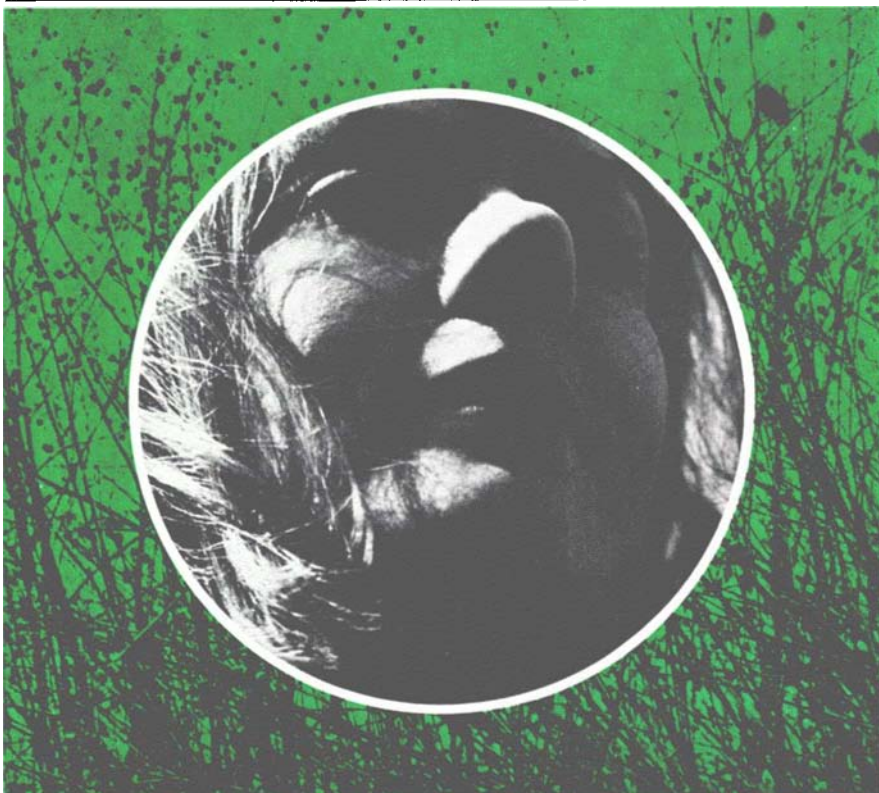

whatever  
the allergen  
'broad-spectrum'  
**Depo-Medrone**  
provides  
anti-inflammatory  
protection during  
the hay fever  
season

**Upjohn**

Whatever the allergen, 'broad-spectrum' Depo-Medrone suppresses all phases of the inflammatory response to provide the pronounced and sustained relief that can make the allergy patient's summer symptom-free.

With one injection (2 cc.) given at the beginning of the season when symptoms appear, "80 per cent of cases are clear of symptoms for the season."<sup>1</sup> The dramatic quality of relief afforded by Depo-Medrone is borne out by such patient comments as "I feel completely normal – as if it were Winter," "I have even been able to cut the grass," "Better than any tablet or spray I have ever had." These were typical of comments from a study in which the majority of the patients obtained virtually complete relief for the duration of the hay fever season.<sup>2</sup>

**Supplied:** 40 mg./cc. methylprednisolone acetate in 1 cc., 2 cc. and 5 cc. vials.

1. *Practitioner* (1967), **198:85**.

2. *Practitioner* (1965), **194:676**.

6712 REGISTERED TRADEMARK. MEDRONE TRADEMARK. DEPO GB 3821.2  
Full product information available on request  
UPJOHN LIMITED • CRAWLEY • SUSSEX

Please mention *The Journal of Laryngology and Otology* when replying to advertisements

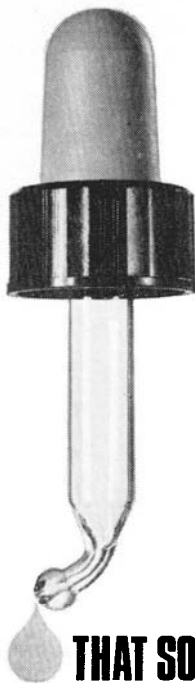

## THE DROP THAT SOOTHES THE INFECTED EAR

'Otosporin' rapidly destroys virtually *all* bacteria commonly found in ear infections, reduces irritation, inflammation and pain. 'Otosporin' brand Drops contain polymyxin B sulphate, neomycin sulphate and hydrocortisone in a bland suspension designed to facilitate penetration. Issued in bottles of 5 ml.

## 'OTOSPORIN'

Full information is available on request.



**Burroughs Wellcome & Co. London**  
(The Wellcome Foundation Ltd.)

---

Please mention *The Journal of Laryngology and Otology* when replying to advertisements