

# CLAY MINERALOGY OF MISSISSIPPIAN STRATA OF SOUTHEAST IOWA

*by*

JOHN B. HAYES

University of Iowa, Iowa City, Iowa

## ABSTRACT

Clay mineral suites were extracted from 125 biocalcarenites, dolomites, mudstones and arenaceous rocks from the marine Keokuk, Warsaw and Salem formations of Mississippian age from southeast Iowa and nearby portions of Illinois and Missouri. Well crystallized illite, 2M<sub>1</sub> polytype, randomly interstratified illite-montmorillonite, and quartz are in all clay suites. In the south part of the area, trioctahedral chlorite is absent or rare in Keokuk rocks, but is increasingly abundant upward in the section. Kaolinite is confined to the upper part of the section. In the north part of the area, the same upward order of appearance prevails, but the first appearances of chlorite and kaolinite are shifted downward in the stratigraphic section. This distribution of clay minerals is similar to that found by investigators in other areas: kaolinite confined near shore, chlorite in an intermediate position and illite concentrated farther from shore. Clay mineral evidence, combined with petrographic and stratigraphic data, strongly indicates that the type Mississippian strata of southeast Iowa were deposited in a southward regressing epicontinental sea.

Vermiculite and abundant mixed-layer illite-montmorillonite, weathering products of chlorite and illite, respectively, mark a local unconformity between lower and upper members of the Warsaw Formation on the crest of the Warsaw Anticline.

## INTRODUCTION

Strata exposed in southeast Iowa and nearby portions of Illinois and Missouri are part of the classic type Mississippian section for North America (Fig. 1). Though these marine rocks have been studied for more than a century, many stratigraphic problems attending them remain unsolved. Many difficulties arise because the concepts of sedimentary facies and facies fossils have been unused in attempts to erect time-stratigraphic and formational boundaries.

The writer felt that clay mineral data might be useful in stratigraphic studies. Specifically, (1) the nature, (2) the areal and stratigraphic distribution, and (3) the environmental significance of the clays would be worth investigating. Many workers have demonstrated that clay mineral distribution varies systematically with physical and chemical differences in marine environments, both ancient and modern. Interpretation of such distributions

in many instances is equivocal. However, as pointed out by Weaver (1960), when clay mineral data are combined with petrographic, paleontologic and field evidence, important geologic conclusions can result. The present paper reports on such an integrated study.

Dr. S. A. Tyler, Dr. S. W. Bailey and Dr. M. L. Jackson, all of the University of Wisconsin, rendered assistance and encouragement during the

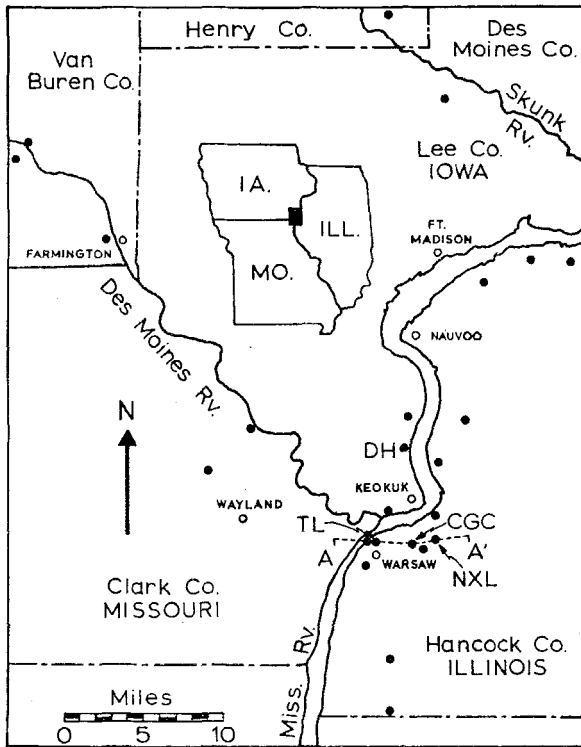

FIGURE 1.—Location map, with measured stratigraphic sections and collecting sites shown as black dots.

investigations, for which the writer is most grateful. The writer acknowledges the support of the National Science Foundation in the form of Predoctoral Fellowships from 1956 through 1960.

### GEOLOGIC SETTING

Formations exposed in the study area are, from oldest to youngest, Burlington, Keokuk, Warsaw, Salem and St. Louis. All are marine deposits of Mississippian age. Van Tuyl (1925) gives thorough descriptions of the formations and their fossils.

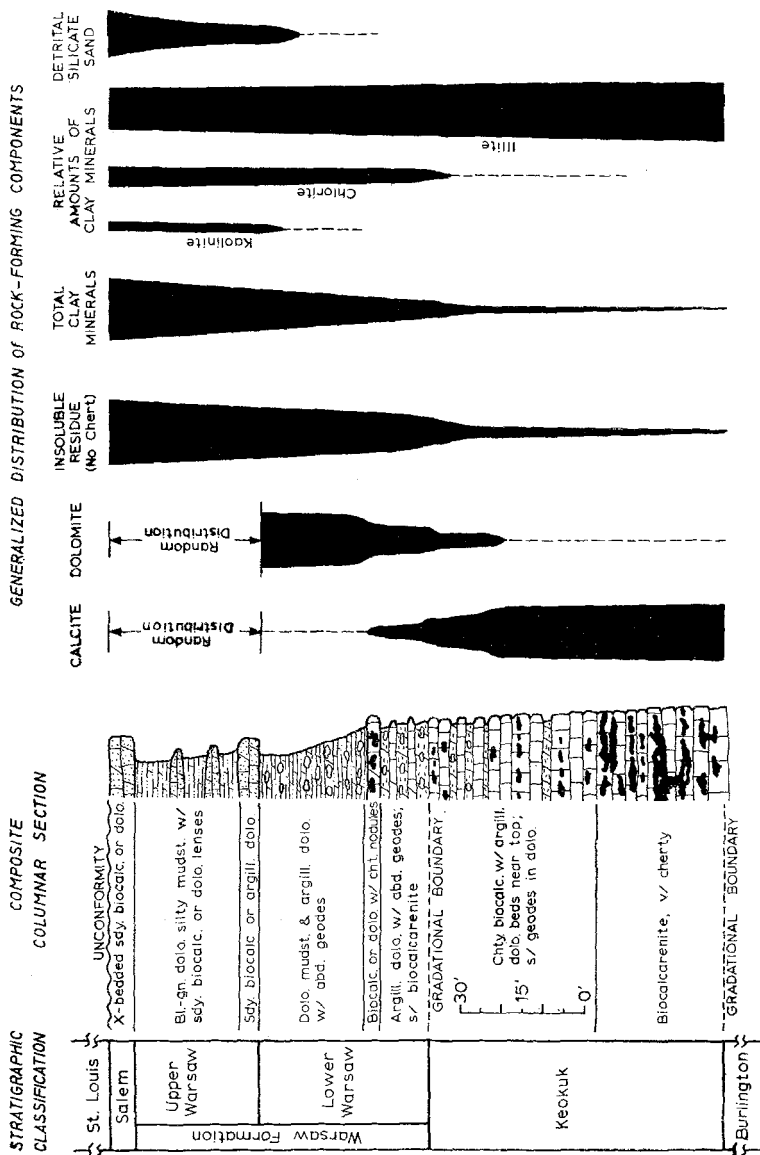

FIGURE 2.—Stratigraphic classification and generalized stratigraphic distribution of rock-forming components in Mississippian strata of southeast Iowa. The diagram is based on considerable detailed quantitative data.

Figure 2 summarizes the several systematic and progressive changes in amount and kind of rock-forming components upward through the Keokuk, Warsaw and Salem. The Keokuk Formation is mostly cherty biocalcarenite, composed of sand-size fragments of crinoids, bryozoans and other organisms. The Keokuk becomes increasingly dolomitic toward the top, with concomitant increase of acid-insoluble, fine-grained residue, including clay minerals. The upward trend to argillaceous dolomites and dolomitic mudstones continues through the lower Warsaw. In the upper Warsaw, detrital quartz grains of medium sand size appear in significant amounts. The abundance of detrital sand increases to the point where sandstone lenses occur locally in the Salem, the uppermost unit under consideration.

These general trends are well expressed over the entire study area, but any given exposure may deviate in details. For example, biocalcarenite lenses occur in the Salem at some places, and detrital sand appears in the lower Warsaw at others. Regional trends in clay mineral distribution parallel the regional lithologic trends, though the former are independent of local irregularities in the latter. That is, clay minerals from intimately interbedded mudstones, dolomites, biocalcarenites and sandstones are the same in amount and kind.

The marked increase in amount and particle size of terrigenous detritus upward through the section has led Van Tuyl (1925) and others to suggest gradual retreat of the Mississippian sea across southeast Iowa during Keokuk, Warsaw and Salem time. This implies that the formations together are a discrete wedge of sediments formed during the regression, that they had a common source, and that in gross aspect they record continuous deposition. The wedge has as its upper boundary a regional unconformity at the base of the St. Louis Formation. Clay mineral data strengthen these interpretations, as will be demonstrated in the next sections.

#### NATURE OF CLAY MINERALS

Clay mineral suites ( $-2 \mu$ ) were extracted from 125 limestones, dolomites, calcareous mudstones and arenaceous rocks for study by X-ray diffraction and supplementary techniques. Representative samples of the rocks, crushed to pass a 100-mesh sieve, were given the following treatments as described by Jackson (1956, Chap. 2): carbonate removal with sodium acetate, pyrite and organic matter removal with  $H_2O_2$ , free iron oxide and hydroxide removal with sodium dithionite-citrate-bicarbonate. The clay minerals thus released were dispersed in pH 9.5  $Na_2CO_3$ , and a cut at  $2 \mu$  equivalent spherical diameter was made by centrifugation. The clay minerals then were Mg-saturated (Jackson, 1956, p. 184); and unsolvated, parallel-orientation specimens dried from ethanol were prepared on glass slides for X-ray analysis. Three or four drops of 30 percent glycerol in ethanol placed on the dry specimen slide were sufficient for solvation, when solvation was necessary.

Clay minerals of the Keokuk, Warsaw and Salem formations exposed at locality DH (Fig. 1) are typical for the rocks in the study area. Figure 3 shows

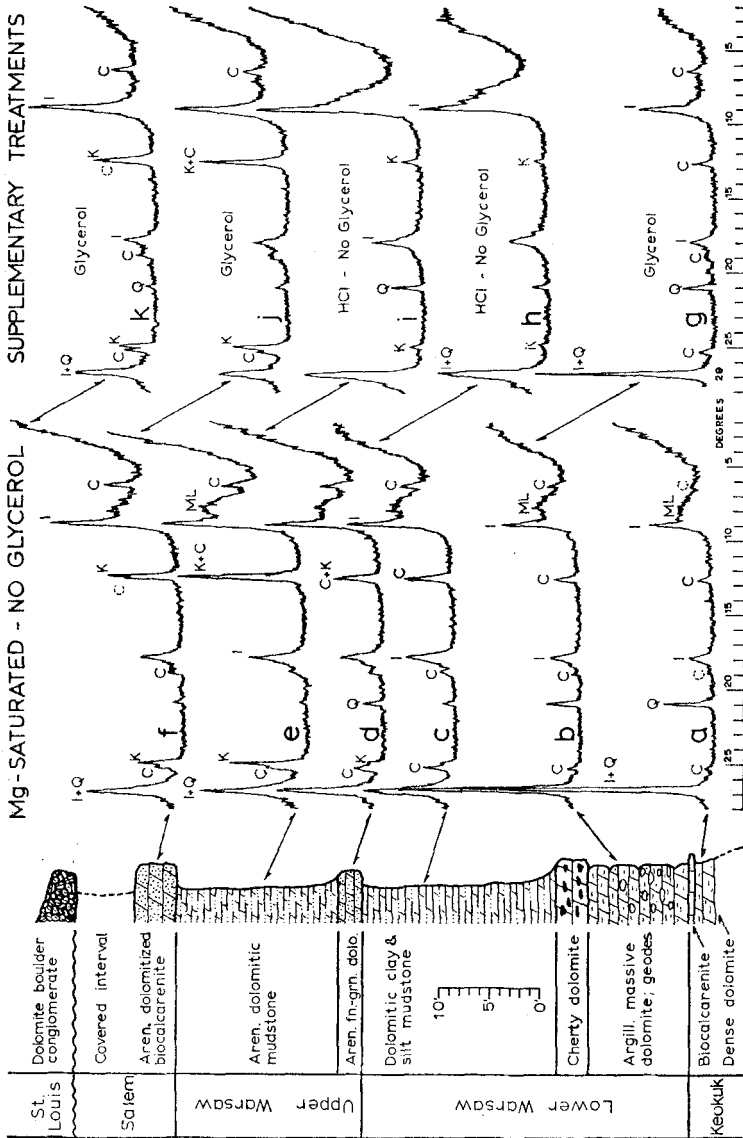

FIGURE 3.—Locality DH, diffractometer traces of clay minerals in relation to stratigraphic position for a typical Mississippian exposure in southeast Iowa. C, chlorite; I, illite; K, kaolinite; ML, mixed-layer illite-montmorillonite; Q, quartz. Dotted letters indicate very weak or poorly resolved peaks.

diffractometer traces of clay mineral suites in relation to stratigraphic position.

Illite, the clay-size mica of sediments, is dominant and ubiquitous in the clay mineral suites studied. It is identified by sharp, intense diffraction maxima from 001 and 003 planes with spacings of about 10.0 Å and 3.33 Å, respectively, the latter coinciding with the most intense maximum of quartz at 3.35 Å. This Mississippian illite is the 2M<sub>1</sub> polytype as discussed by Smith and Yoder (1956).

Mixed-layer material composed of randomly interstratified illitelike and montmorillonitelike layers produces a broad, diffuse peak at about 12 Å, without glycerol treatment. The broad 12 Å peak disappears upon introduction of glycerol into the expansible interlayer positions, but the mixed-layer material remains expressed as shoulders on both sides of the sharp 001 illite peak (Fig. 3, patterns e and j).

Expansible montmorillonitelike layers constitute no more than 20 percent of the mixed-layer material, the remaining 80 percent or more being non-expansible, 10 Å mica layers. All clay mineral suites studied contain mixed-layer clay with this 4:1 ratio of nonexpansible to expansible layers.

Chlorite is abundant in many clay mineral suites. It is composed of non-expansible layers with a series of 00 $l$  diffraction maxima of 14 Å periodicity. The relative intensities of 001, 002, 003 and 004 reflections (Fig. 3, pattern c) are similar to those of ideal chlorite as described by Bradley (1954), with 002 characteristically being the most intense. The chlorite is trioctahedral, with the 060 spacing at about 1.54 Å. The yellow color assumed by a warm HCl solution upon chlorite dissolution suggests appreciable iron in the chlorite.

Many upper Warsaw and Salem specimens contain kaolinite in small to moderate amounts. All suites containing kaolinite also have chlorite. The presence of kaolinite may be determined by dissolving the chlorite with warm HCl, any remaining 00 $l$  spacings with 7 Å periodicity then being assigned to kaolinite (Fig. 3, pattern i). In suites containing more than a few percent kaolinite, 002 of kaolinite at 3.57 Å and 004 of chlorite at 3.53 Å, though close in  $d$  spacing, are resolved either as two separate peaks, a peak with two nodes or a strongly asymmetric peak (Fig. 3, patterns e, f and k). The crystallinity of the kaolinite, or the degree of orderly stacking of 7 Å layers, could not be determined.

Clay-size quartz is in all suites in negligible to moderate amounts. It is preferentially concentrated in clay suites from the less argillaceous rocks, that is, fossiliferous limestones and some dolomites.

## STRATIGRAPHIC DISTRIBUTION OF CLAY MINERALS

Of significance is the stratigraphic distribution of the various clay minerals. Illite, mixed-layer material and clay-size quartz are found throughout the sedimentary sequence. Chlorite is absent or rare in Keokuk rocks but is increasingly abundant upward through the Warsaw and Salem. Kaolinite is

confined to the upper part of the section (Fig. 2). The DH exposure well exemplifies this general distribution (Fig. 3).

Figure 4A shows semiquantitative abundances of clay minerals in relation

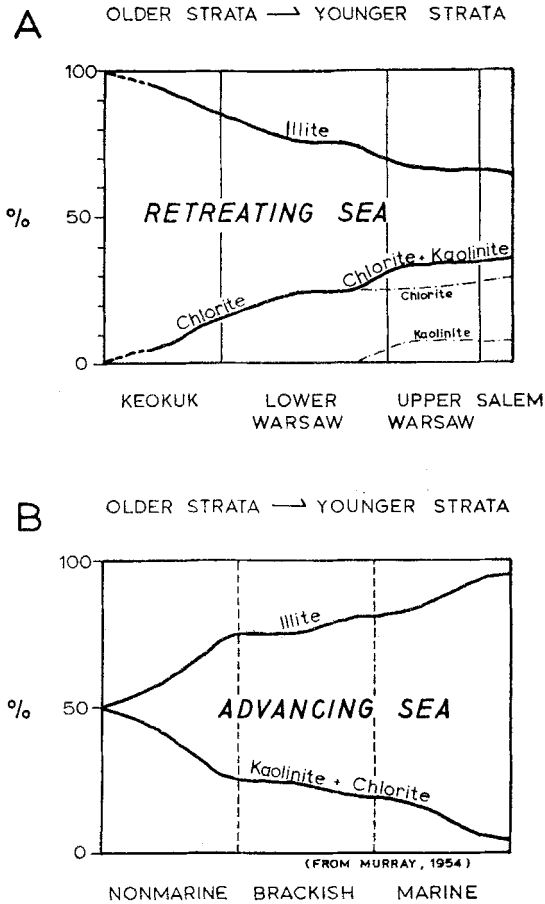

FIGURE 4.—A. Clay mineral percentages in relation to stratigraphic position in the Keokuk–Warsaw–Salem sequence, the deposits of a retreating sea. B. Clay mineral percentages in relation to stratigraphic position and depositional environments in Pennsylvanian cyclothem of western Illinois, the deposits of an advancing sea. From Murray (1954).

to stratigraphic position. The data were obtained by an X-ray diffraction method patterned after that of Murray (1954, p. 57), based on relative intensities of basal reflections. The plotted values are average compositions of all

the clay suites from each of the indicated stratigraphic or lithologic units. The increase from older to younger strata in chlorite and kaolinite contents relative to illite is apparent.

### STRATIGRAPHIC SIGNIFICANCE OF CLAY MINERAL DISTRIBUTION

Murray (1954, p. 60) presents a diagram of semiquantitative clay mineral composition of rocks from Pennsylvanian cyclothem deposits in nonmarine, brackish water and marine environments in western Illinois, not far from southeast Iowa. Murray's diagram is reproduced in Fig. 4B. Kaolinite and

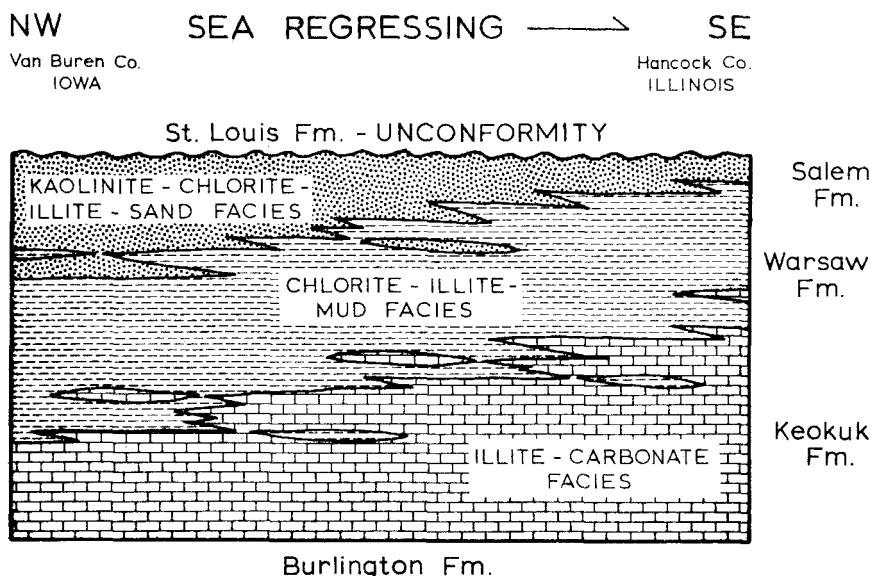

FIGURE 5.—Idealized marine lithofacies-clay mineral relations of the regressing Keokuk-Warsaw-Salem sea.

chlorite content decreases and illite content increases from nonmarine to marine rocks. Thus, it may be inferred that kaolinite and chlorite are concentrated in near-shore estuarine, deltaic and lagoonal environments, and that they are less abundant with respect to illite in deposits of open marine environments. The clay mineralogy literature is replete with papers that reach similar conclusions, though their reasons for doing so may differ from one another (Weaver, 1958a, p. 163; 1958b, p. 258).

Similarities in geographic location, geologic age, provenance and mineralogy between the strata studied by Murray (1954) and the Mississippian strata under discussion invite comparison. Although the sequence studied by Murray is that of an advancing sea, and the Keokuk-Warsaw-Salem sequence



is likely that of a retreating sea, one situation is essentially the reverse of the other in relation to physical and chemical factors controlling clay mineral distribution in the marine environment. In fact, Fig. 4A appears as a distorted mirror image of the marine and brackish environment portions of Murray's diagram, Fig. 4B. The abundance of chlorite in upper Warsaw and Salem rocks and the appearance of kaolinite are consistent with the interpretation of near-shore depositional environments for the upper part of the section.

Figure 5 is a generalized facies diagram from northwest to southeast across the study area. Three distinct clay mineral lithofacies are recognized. (1) Lowest is the illite-carbonate facies in which biocalcareonites and some dolomites are the dominant rock types, with illite being the characteristic clay mineral in the small total amount of clay in the carbonate rocks. (2) Next is the chlorite-illite-mud facies in which calcareous mudstones rich in clay, silt and fine sand-size terrigenous particles are most abundant, with illite dominant and chlorite conspicuous in clay suites. (3) Uppermost is the kaolinite-chlorite-illite-sand facies. Kaolinite and detrital quartz sand are minor components only, but their presence distinguishes the facies. Mudstone is the dominant rock type; illite and chlorite are the dominant clay minerals.

Clay mineral distribution gives an indication of the direction in which the shoreline regressed. The first appearance upward in the stratigraphic section of a given facies is lower in the section in the north part of the area than in the south part. This distribution of lithofacies and clay mineral facies implies that the near-shore zone of kaolinite and chlorite deposition was in the north at an earlier time than in the south. Thus, the very near-shore zone, and hence, the sea, retreated from north to south.

#### CLAY MINERALS AT AN UNCONFORMITY

The occurrence of vermiculite in the rocks studied is of some interest. Figure 6 is a structural cross section, A-A', through the Warsaw Anticline (Bell, 1932), east of Warsaw, Illinois (Fig. 1). Three measured sections, TL, CGC and NXL delineate the structure. The geode-bearing mudstone bed of the lower Warsaw Formation is greatly attenuated in thickness at CGC on the crest of the Warsaw Anticline, as compared to sections TL and NXL.

Two interpretations of this thinning are possible. (1) The Warsaw Anticline was a positive area during lower Warsaw time, but not subaerially exposed, so that the anticlinal crest received less than normal thickness of sediment. (2) The Warsaw Anticline came into being or, if already present, experienced renewed folding during Warsaw time while associated subaerial erosion removed the uppermost part of the lower Warsaw on the anticlinal crest. This would produce, at least locally, an unconformity within the Warsaw Formation.

Because certain clay minerals are sensitive to environmental changes and undergo alterations accordingly, clay mineral evidence can be used to decide between the two choices. Of all the clay mineral suites examined, in only two does vermiculite occur in the place of chlorite. The two bedrock specimens

were collected at CGC on the crest of the Warsaw Anticline, one at the top of the abnormally thin mudstone, and the other from the base of the limestone bed just above the mudstone, as shown in Fig. 6.

Figure 7 shows diffraction patterns of clay mineral suites from the crest of the Warsaw Anticline. Patterns c and d are of the two suites that contain vermiculite. The very strong 001 reflection at about  $14 \text{ \AA}$ , relative to the intensity of 002 at  $7 \text{ \AA}$ , is characteristic of Mg-saturated vermiculite. The interlayer distance is unexpanded by glycerol—another characteristic of vermiculite (Fig. 7, pattern k). Heating at  $400^\circ \text{C}$  for 1 hr removes the interlayer

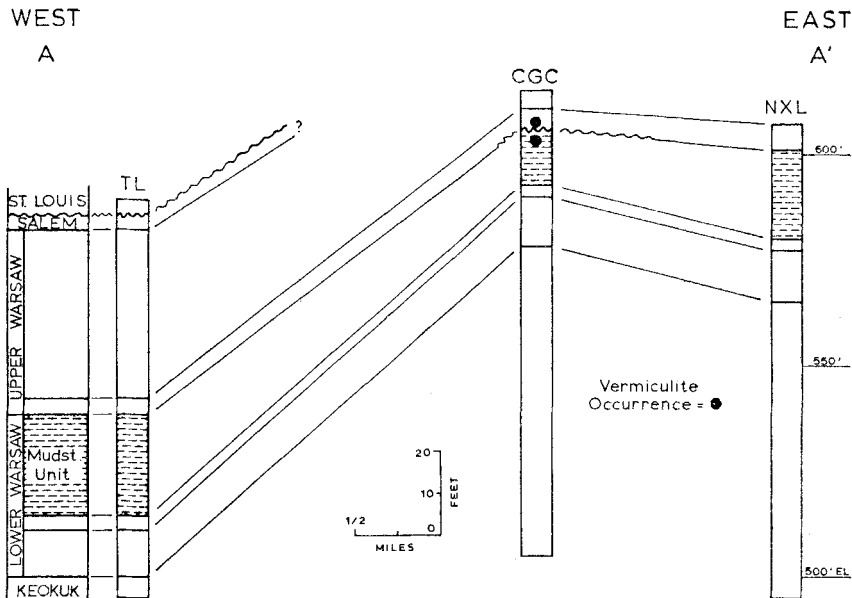

FIGURE 6.—Geologic structure section, A-A', across the Warsaw Anticline. The abnormally thin section of lower Warsaw mudstone coincides with the anticlinal crest at locality CGC. Vermiculite marks a local unconformity.

water, causing the repeat distance to collapse to about  $10 \text{ \AA}$ , coincident with and unresolved from the 001 illite peak in this position (Fig. 7, patterns i and j). The vermiculitelike clay mineral is destroyed by the same HCl treatment which destroys chlorite (pattern l). There is indication of some random interstratification of chlorite with the vermiculite.

The vermiculite probably originated from weathering of chlorite in the lower Warsaw mudstone. Randomly interstratified illite-montmorillonite is much more abundant than well-crystallized  $2M_1$  illite in the suite shown in Fig. 7, pattern d. This also suggests weathering. This suite is in marked contrast to all other clay mineral suites investigated. Work by Dalton, Swineford and Jewett (1958) with a fossil soil zone in Desmoinesian shale just beneath

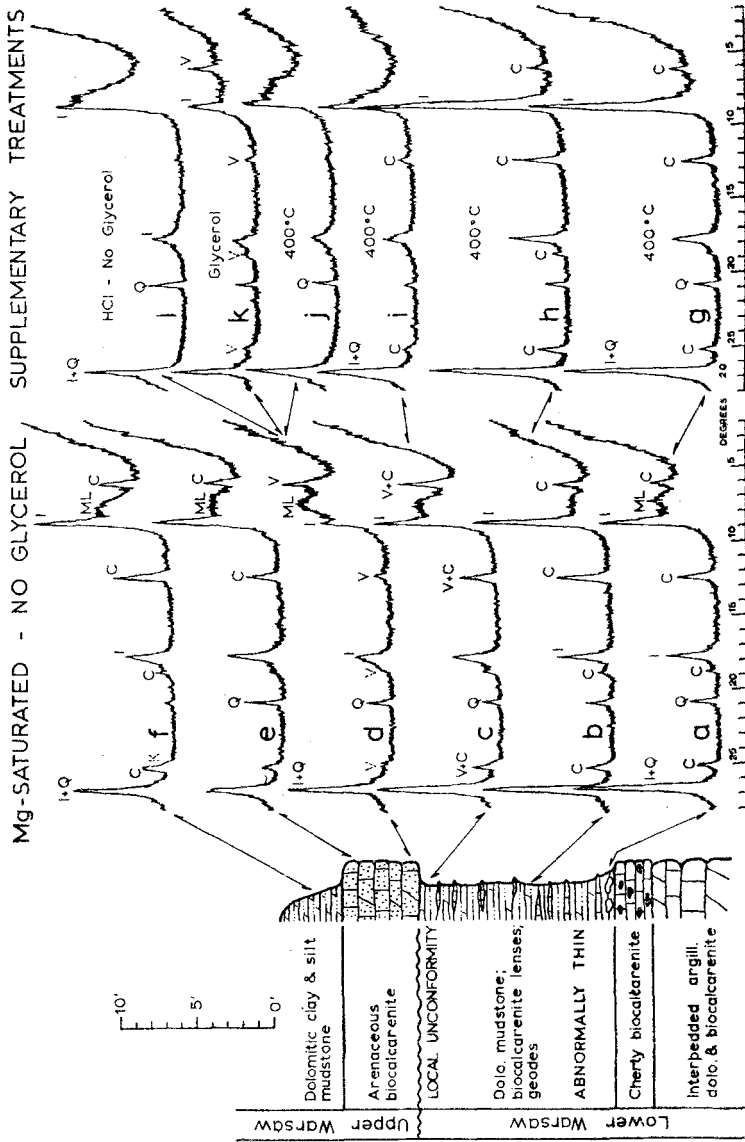

FIGURE 7.—Locality CGC, diffractometer traces of clay minerals in relation to stratigraphic position on the local unconformity within the Warsaw Formation on the crest of the Warsaw Anticline. C, chlorite; I, illite; K, kaolinite; ML, mixed-layer illite-montmorillonite; Q, quartz; V, vermiculite. Dotted letters indicate very weak or poorly resolved peaks.

the Desmoinesian–Missourian disconformity in Kansas shows that: (1) the normal marine illite was hydrated with great increase in the amount of mixed-layer clays and; (2) there was progressive modification and destruction of chlorite, with concomitant production of mixed-layer and vermiculite minerals upon weathering. These are the same effects demonstrated for the Warsaw clays.

Clay mineral suites from strata a few feet above and below the vermiculite occurrences have abundant well-crystallized illite and chlorite, rather than vermiculite (Fig. 7, patterns a and f). Therefore, it is concluded that deformation and subaerial weathering took place after deposition of the lower Warsaw mudstone, and that weathered material was incorporated into the base of the overlying bed. Weathering was accompanied by erosion which removed part of the lower Warsaw mudstone to produce an abnormally thin section. Therefore, an unconformity of local extent exists between lower and upper Warsaw strata on the crest of the Warsaw Anticline, and perhaps elsewhere. The close association of vermiculite with an abnormally thin mudstone section confined to the crest of an anticline is no mere coincidence, but must have real geologic significance. Flexing of the Warsaw Anticline in mid-Warsaw time probably was a local response to the widespread epeirogenic forces that caused the Mississippian sea to retreat during Keokuk–Warsaw–Salem time.

### CONCLUSIONS

Data on stratigraphic and areal distribution of the various clay minerals, combined with field and petrographic evidence, allow three major conclusions. (1) The sequence of Mississippian strata from the Keokuk through the Salem is a discrete unit in the sedimentary-tectonic sense, being the deposits of a regressing epicontinental sea. (2) The near-shore zone, with its concentration of kaolinite and chlorite relative to illite, moved from north to south across southeast Iowa during the regression. (3) A local unconformity marked by vermiculite within the Warsaw Formation attests to mid-Warsaw tectonic deformation and subaerial erosion.

### REFERENCES

- Bell, A. H. (1932) Structure and oil possibilities of the Warsaw area, Hancock County, Illinois: Ill. Geol. Surv., Ill. Petroleum, no. 24, 17 pp.
- Bradley, W. F. (1954) X-ray diffraction criteria for the characterization of chloritic material in sediments: in *Clays and Clay Minerals*, Nat. Acad. Sci.–Nat. Res. Council, pub. 327, pp. 324–334.
- Dalton, J. A., Swineford, Ada, and Jewett, J. M. (1958) Clay minerals at a Pennsylvanian disconformity: in *Clays and Clay Minerals*, Nat. Acad. Sci.–Nat. Res. Council, pub. 566, pp. 242–252.
- Jackson, M. L. (1956) *Soil Chemical Analysis—Advanced Course*: published by the author, Madison, Wisconsin, 991 pp.
- Murray, H. H. (1954) Genesis of clay minerals in some Pennsylvanian shales of Indiana and Illinois: in *Clays and Clay Minerals*, Nat. Acad. Sci.–Nat. Res. Council, pub. 327, pp. 47–67.

CLAY MINERALOGY OF MISSISSIPPIAN STRATA OF SOUTHEAST IOWA 425

- Smith, J. V. and Yoder, H. S. (1956) Experimental and theoretical studies of the mica polymorphs: *Min. Mag.*, v. 31, pp. 209–235.
- Van Tuyl, F. M. (1925) The stratigraphy of the Mississippian formations of Iowa: *Iowa Geol. Survey Ann. Rept.*, v. 30, pp. 33–349.
- Weaver, C. E. (1958a) A discussion on the origin of clay minerals in sedimentary rocks: in *Clays and Clay Minerals*, Nat. Acad. Sci.–Nat. Res. Council, pub. 566, pp. 159–173.
- Weaver, C. E. (1958b) Geologic interpretation of argillaceous sediments; Part 1. Origin and significance of clay minerals in sedimentary rocks: *Amer. Assoc. Petroleum Geologists Bull.*, v. 42, pp. 254–271.
- Weaver, C. E. (1960) Possible uses of clay minerals in the search for oil: in *Clays and Clay Minerals*, v. 8, Pergamon Press, New York, pp. 214–227.