

# Edinburgh Mathematical Society.

## LIST OF MEMBERS.

TWENTY-SIXTH SESSION 1907-1908.

- 1 V. RAMASWAMI AIYAR, M.A., Deputy Collector, Arni, India  
ROBERT J. ALEY, Professor of Mathematics, Indiana University,  
Bloomington, Indiana, U.S.A.  
JOHN ALISON, M.A., F.R.S.E., Headmaster, George Watson's  
College, Edinburgh  
R. E. ALLARDICE, M.A., Professor of Mathematics, Leland-  
Stanford Junior University, Palo Alto, California
- 5 WM. ANDERSON, M.A., F.R.S.E., George Watson's College,  
Edinburgh  
JAMES ARCHIBALD, M.A., F.R.S.E., 52 Polwarth Gardens,  
Edinburgh  
LOUDON ARNEIL, M.A., Provincial Training College, Glasgow  
PAUL AUBERT, Professeur au Lycée, Henri V., Paris  
A. J. GUNION BARCLAY, M.A., F.R.S.E., High School, Glasgow
- 10 J. C. BEATTIE, D.Sc., F.R.S.E., Professor of Applied Mathe-  
matics and Experimental Physics, South African College,  
Cape Town  
ROBT. J. T. BELL, M.A., B.Sc., 90 Barrington Drive, Glasgow  
PETER BENNETT, Glasgow and West of Scotland Technical  
College, Glasgow  
EDWARD BLADES, M.A., B.Sc., George Watson's Ladies' College,  
Edinburgh  
JAMES BOLAM, Leith Nautical College, Leith
- 15 Professor T. J. FA BROMWICH, M.A., F.R.S., Devana Terrace,  
Cambridge  
R. R. BRODIE, Scottish Provident Institution, St Andrew  
Square, Edinburgh  
A. BROWN, M.A., B.Sc., Professor of Applied Mathematics,  
South African College, Cape Town  
H. H. BROWNING, M.A., 128 Byres' Road, Glasgow  
Major J. BRUCE-KINGSMILL, R.A., F.C.S., c/o E. S. Hindley  
& Sons, Engineers, Bourton, Bath
- 20 JAMES BUCHANAN, M.A., 9 St Andrew Square, Edinburgh

- A. G. BURGESS, M.A., F.R.S.E., Ladies' College, Queen Street, Edinburgh (*Co-Editor of Proceedings*)
- J. W. BUTTERS, M.A., B.Sc., F.R.S.E., Rector, The Academy, Ardrossan
- JOHN F. CAMERON, M.A., Fellow and Tutor of Caius College, Cambridge
- JOHN CAMPBELL, B.Sc., Allan Glen's School, Glasgow
- 25 GEORGE A. CARSE, M.A., D.Sc., Lecturer on Natural Philosophy, The University, Edinburgh
- HORATIO S. CARSLAW, M.A., D.Sc., F.R.S.E., University, Sydney, Australia
- CHARLES CHREE, M.A., D.Sc., F.R.S. 25 Mount Ararat Road, Richmond, Surrey
- GEORGE CHRYSAL, M.A., LL.D., Sec. R.S.E., Professor of Mathematics, University, Edinburgh (*Hon. Member*)
- J. B. CLARK, M.A., F.R.S.E., Headmaster, George Heriot's School, Edinburgh
- 30 PETER COMRIE, M.A., B.Sc., Boroughmuir School, Edinburgh
- JAMES I. CRAIG, M.A., B.A., Survey Department, Cairo, Egypt
- G. E. CRAWFORD, M.A., Manor House, Clifton, Bristol
- LAWRENCE CRAWFORD, M.A., D.Sc., Professor of Mathematics, South African College, Cape Town
- R. F. DAVIS, M.A., Burlington Avenue, Kew Gardens, London, W.
- 35 J. MACALISTER DODDS, M.A., Peterhouse, Cambridge
- A. C. DIXON, M.A., F.R.S., Professor of Mathematics, Queen's College, Belfast
- JAMES M. DOGGART, B.A., High School, Kirkcaldy
- J. A. DOIG, George Watson's College, Edinburgh
- A. GRAHAM DONALD, M.A., F.F.A., Scottish Provident Institution, Edinburgh
- 40 CHAS. S. DOUGALL, M.A., Rector, The Institution, Dollar
- JOHN DOUGALL, M.A., D.Sc., Kippen, Stirlingshire
- ALBERT DRIVER, George Watson's College, Edinburgh
- DAVID DRYSDALE, M.A., Royal Academy, Irvine
- JOHN DUNBAR, M.A., B.Sc., The Academy, Ardrossan
- 45 GEORGE DUTHIE, M.A., B.A., F.R.S.E., Superintending Inspector of Schools and Statist, Salisbury, Rhodesia
- Professor JAMEHEDJI EDALJI, 72 Yocho Machi, Ushigome Ku, Tokyo, Japan
- GEORGE EDNIE, M.A., B.Sc., The Academy, Dumfries
- JAMES M. EDWARD, M.A., Headmaster, Wigtown
- JOHN EDWARDS, M.A., The Academy, Ardrossan
- 50 JAS. ERSKINE-MURRAY, D.Sc., 2 Crown Gardens, Glasgow
- R. M. FERGUSON, Ph.D., LL.D., F.R.S.E., 5 Douglas Gardens, Edinburgh
- WM. FINLAYSON, 84 Pilrig Street, Edinburgh

- DAVID KENNEDY-FRASER, B.Sc., 95 George Street, Edinburgh  
 Rev. NORMAN FRASER, B.D., 84 Craiglea Drive, Edinburgh
- 55 W. G. FRASER, M.A., H.M.I.S., 18 Glebe Avenue, Stirling  
 JAMES M. FREW, M.A., B.Sc., 17 Highburgh Road, Dowanhill,  
 Glasgow  
 J. D. FULTON, M.A., B.Sc., Boroughmuir Higher Grade School,  
 Edinburgh  
 ALEXANDER H. GARDNER, M.A., B.Sc., Headmaster, Lochgilphead  
 Wm. GENTLE, B.Sc., George Heriot's School, Edinburgh
- 60 H. T. GERRANS, M.A., Fellow and Tutor of Worcester College,  
 Oxford  
 GEORGE A. GIBSON, M.A., LL.D., Professor of Mathematics,  
 West of Scotland Technical College, Glasgow (*Hon. Member*)  
 JAMES GOODWILLIE, M.A., B.Sc., Lecturer on Mathematics,  
 King's College, Aberdeen  
 GEORGE GREEN, M.A., 3 Edgefauld Terrace, Springburn,  
 Glasgow  
 Professor Sir A. G. GREENHILL, M.A., F.R.S., 1 Staple Inn,  
 London, W.C. (*Hon. Member*)
- 65 W. G. GREENSTREET, M.A., Headmaster, Marling School, Stroud  
 P. S. HARDIE, M.A., B.Sc., Ras-el-tin, Government School,  
 Alexandria, Egypt  
 R. P. HARDIE, M.A., Assistant to the Professor of Logic,  
 University, Edinburgh  
 J. HARKNESS, M.A., B.Sc., Physical Laboratory, The University,  
 Edinburgh  
 E. W. HERBERT, M.A., The Academy, Edinburgh
- 70 Wm. HISLOP, M.A., Headmaster, Supplementary School,  
 Dumbarton  
 ALEX. HOLM, M.A., Girls' High School, Glasgow  
 JAMES HORNE, M.A., George Watson's College, Edinburgh  
 E. M. HORSBURGH, M.A., B.Sc., A.M.I.C.E., Lecturer in  
 Mathematics, The University, Edinburgh  
 W. R. HUGHES, B.A., Fellow of Jesus College, Cambridge
- 75 ANDREW HUTCHISON, M.A., B.Sc., John Street H.G. School,  
 Glasgow  
 PETER D. INNES, M.A., B.Sc., 9 Park Street, Cambridge  
 JOHN JACK, M.A., Professor of Mathematics, Wilson College,  
 Bombay  
 W. JACK, M.A., LL.D., Professor of Mathematics, University,  
 Glasgow (*Hon. Member*)  
 JOHN JACKSON, M.A., Victoria Building, Greenock Road, Paisley
- 80 H. A. JAMIESON, M.A., The Academy, Ayr  
 JOHN JEFFREY, M.A., B.Sc., Rector, High School, Selkirk  
 Wm. JEFFREY, M.A., Academy, Banff  
 GEORGE JOHNSTON, M.A., Spier's School, Beith  
 D. M. JOHNSTONE, M.A., B.Sc., George Heriot's School, Edinburgh

- 85 ARCHIBALD KING, M.A., B.Sc., Rector, The Academy, Castle-Douglas  
 JOHN W. KIPPEN, Headmaster, St Andrew's School, Dundee  
 CARGILL G. KNOTT, D.Sc., F.R.S.E., Lecturer on Applied Mathematics, University, Edinburgh  
 ARCHIBALD LANG, M.A., B.Sc., H.M.I.S., 21 Cartha Street, Langside, Glasgow  
 P. R. SCOTT LANG, M.A., B.Sc., F.R.S.E., Professor of Mathematics, University, St Andrews
- 90 W. S. LAURIE, M.A., 34 Percy Street, Blyth, Northumberland  
 GEORGE LAWSON, M.A., Rector, Waid Academy, Anstruther  
 R. LEES, M.A., B.Sc., Headmaster, The Academy, Fraserburgh  
 G. M. K. LEGGETT, 28 Cambridge Street, Eccleston Square, London, S.W.  
 ALEXANDER LEIGHTON, M.A., B.Sc., Morgan Academy, Dundee
- 95 WM. A. LINDSAY, M.A., B.Sc., Provincial Training College, Glasgow (*President*)  
 JAMES LITTLEJOHN, M.A., 11 Kinnaird Street, Arbroath  
 ALEX. V. LOTHIAN, M.A., B.Sc., F.R.S.E., Science Lecturer, Provincial Training College, Glasgow  
 J. BARRIE-LOW, M.A., Wrenschtown House, Observatory Road, Cape Town  
 WM. H. LOVE, M.A., Provincial Training College, Glasgow
- 100 JOHN H. M'ALPINE, M.I.N.A., 615 Walnut Street, Philadelphia  
 NEIL M'ARTHUR, M.A., B.Sc., Mathematical Department, The University, Glasgow  
 JAMES A. M'BRIDE, B.A., B.Sc., Allan Glen's School, Glasgow  
 JAS. M'CUBBIN, B.A., F.R.S.E., Rector, The Academy, Kilsyth  
 JAMES A. MACDONALD, M.A., B.Sc., F.R.S.E., H.M.I.S., Dingwall, N.B.
- 105 W. J. MACDONALD, M.A., F.R.S.E., Daniel's Stewart's College, The Dean, Edinburgh  
 D. C. M'INTOSH, M.A., B.Sc., F.R.S.E., Ladies' College, Queen Street, Edinburgh  
 J. S. MACKAY, M.A., LL.D., F.R.S.E., 69 Northumberland Street, Edinburgh (*Hon. Member*)  
 ANGUS M'LEAN, B.Sc., C.E., Principal, Technical College, Paisley  
 CHARLES M'LEOD, M.A., D.Sc., Grammar School, Aberdeen
- 110 PETER M'LEOD, M.A., B.Sc., Hillhead High School, Glasgow  
 JESSIE CHRYSAL MACMILLAN, M.A., B.Sc., Corstorphine Hill House, Edinburgh  
 JOHN M'WHAN, M.A., Rossville, Cambuslang  
 JEAN MATTHEW, M.A., c/o Williamson, 57 Marchmont Road, Edinburgh  
 J. B. MEIKLEJOHN, M.A., High School, Dundee

- 115 JOAQUIN DE MENDIZABAL Y TAMBORREL, Professor de Mathe-  
 matique, Palma, 13, Mexico  
 ALEX. J. MERRILEES, M.A., B.Sc., 12 Marchmont Street,  
 Edinburgh  
 W. J. MILLAR, C.E., late Secretary, Instit. Engineers and  
 Shipbuilders in Scotland, 31 Marine Place, Rothesay  
 JOHN MILLER, M.A., West of Scotland Technical College,  
 Glasgow  
 T. HUGH MILLER, M.A., D.Sc., Training College, Isleworth,  
 near London
- 120 WILLIAM MILLER, M.A., 48 Windsor Terrace, St George's  
 Road, Glasgow  
 ARCH. MILNE, M.A., B.Sc., F.R.S.E., Provincial Training  
 College, Edinburgh  
 HUGH MITCHELL, 4 Windsor Street, Dundee  
 JAMES MITCHELL, M.A., B.Sc., F.R.S.E., The Academy,  
 Kilmarnock  
 GEORGE L. MOFFAT, M.A., B.Sc., The Academy, Glasgow
- 125 ALEXANDER MORGAN, M.A., D.Sc., F.R.S.E., Principal,  
 Provincial Training College, Edinburgh  
 ELIZABETH MORRISON, M.A., 23 Brisbane Street, Greenock  
 J. T. MORRISON, M.A., B.Sc., F.R.S.E., Professor of Physics,  
 Stellenbosch, Cape Colony  
 THOMAS MUIR, M.A., LL.D., F.R.S., F.R.S.E., C.M.G.,  
 Superintendent-General of Education, Mowbray Hall,  
 Rosebank, Cape Colony  
 R. FRANKLIN MUIRHEAD, M.A., D.Sc., 64 Great George Street,  
 Hillhead, Glasgow
- 130 ASUTOSH MUKHOPADHYAY, M.A., LL.D., F.R.A.S., F.R.S.E.,  
 Professor of Mathematics, Bhowanipore, Calcutta  
 A. M. C. MUTCH, M.A., B.Sc., Royal Academical Institution,  
 Belfast  
 M. T. NARANIENGAR, M.A., Professor of Mathematics, Central  
 College, Bangalore, South India  
 CHARLES NIVEN, M.A., D.Sc., F.R.S., Professor of Natural  
 Philosophy, University, Aberdeen (*Hon. Member*)  
 A. S. OGILVIE, M.A., B.Sc., Provincial Training College,  
 Edinburgh
- 135 R. T. OMOND, F.R.S.E., 3 Church Hill, Edinburgh  
 W. M. F. ORR, M.A., Professor of Mathematics, Royal College  
 of Science, Dublin  
 L. F. OTTO, M.A., Headmaster, Railway School, Thansi, U.P.,  
 India  
 FRANK R. PEARSON, M.A., George Watson's College, Edinburgh  
 WILLIAM PEDDIE, D.Sc., F.R.S.E., Professor of Physics,  
 University College, Dundee
- 140 GEORGE PHILIP, M.A., B.Sc., George Watson's College, Edinburgh

- WM. EDWARD PHILIP, M.A., H.M.I.S., Aberdeen  
 ROBERT PHILIP, M.A., Hutcheson's Grammar School, Glasgow  
 D. K. PICKEN, Professor of Mathematics, Victoria College,  
 Wellington, New Zealand (*Vice-President*)  
 P. PINKERTON, M.A., F.R.S.E., George Watson's College,  
 Edinburgh (*Hon. Secretary*)  
 145 R. H. PINKERTON, M.A., Professor of Mathematics, University  
 College, Cardiff  
 A. J. PRESSLAND, M.A., F.R.S.E., The Academy, Edinburgh  
 HARRY RAINY, M.A., M.D., F.R.S.E., 16 Great Stuart Street,  
 Edinburgh  
 PETER RAMSAY, M.A., B.Sc., George Watson's College,  
 Edinburgh  
 THOS. T. RANKINE, C.E., B.Sc., Principal, Wigan and District  
 Mining and Technical College, Wigan  
 150 DAVID RENNETT, LL.D., 32 Fountainhall Road, Aberdeen  
 JOHN ROBERTSON, B.Sc., Physical Laboratory, The University,  
 Edinburgh  
 RICHARD D. ROBERTSON, M.A., Allan Glen's School, Glasgow  
 A. J. ROSS, M.A., B.Sc., Sanawar Training College, Punjab,  
 India  
 EDWARD B. ROSS, M.A., Professor of Mathematics, Christian  
 College, Madras  
 155 PETER ROSS, M.A., B.Sc., Broughton H.G. School, Edinburgh  
 ANDREW RUTLEDGE, B.A., 32 Clonmore Road, N. Strand, Dublin  
 ALEX. D. RUSSELL, B.Sc., High School, Falkirk  
 K. J. SANJANA, Professor of Mathematics, Bhaonagar, Bombay  
 CHARLOTTE ANGAS SCOTT, D.Sc., Professor of Mathematics,  
 Bryn Mawr College, Pennsylvania, U.S.A.  
 160 R. F. SCOTT, M.A., Master of St John's College, Cambridge  
 W. SCRIMGEOUR, M.A., B.Sc., 8 Bath Place, Ayr  
 RODERICK M. SHEARER, M.A., B.Sc., 28 Strathearn Road,  
 Edinburgh  
 EDWARD SMART, B.A., B.Sc., The Academy, Perth  
 DUNCAN M. Y. SOMERVILLE, M.A., D.Sc., Lecturer in Applied  
 Mathematics, University of St Andrews  
 165 FRANK SPENCE, M.A., B.Sc., F.R.S.E., Provincial Training  
 College, Edinburgh  
 T. B. SPRAGUE, M.A., LL.D., F.R.S.E., 29 Buckingham  
 Terrace, Edinburgh  
 J. E. A. STEGGALL, M.A., Professor of Mathematics, University  
 College, Dundee  
 ALEX. STEVENSON, M.A., B.Sc., Whitehill School, Glasgow  
 ADAM B. STEWART, M.A., The Ministry of Education, Darb-El-  
 Gamamiz, Cairo, Egypt  
 170 WALTER STEWART, M.A., D.Sc., H.M.I.S., 3 Coates Crescent,  
 Edinburgh

- GEORGE D. C. STOKES, M.A., B.Sc., Mathematical Department,  
The University, Glasgow
- LOUISA STORY, George Watson's Ladies' College, Edinburgh
- WALTER STOTT, Hon. Sec. Liverpool Mathematical Society,  
4 Grasmere Drive, Liscard
- DAVID G. TAYLOR, M.A., University College, Cardiff
- 175 JAMES TAYLOR, M.A., F.R.S.E., The Academy, Edinburgh
- W. S. TEMPLETON, M.A., B.Sc., Professor of Physics, Medical  
and Technical Colleges, Colombo, Ceylon
- J. A. THIRD, M.A., D.Sc., Spier's School, Beith
- H. F. THOMPSON, B.A., Academy, Edinburgh
- W. L. THOMPSON, M.A., B.Sc., Rector, The Academy, Hawick
- 180 JOHN GRAHAM THOMSON, 34 London Street, Edinburgh
- WM. THOMSON, M.A., B.Sc., LL.D., F.R.S.E., Registrar to the  
Cape University, Cape Colony
- W. L. THOMSON, M.A., George Heriot's School, Edinburgh
- JOHN TURNER, M.A., B.Sc., Royal High School, Edinburgh  
(*Hon. Treasurer*)
- CHARLES TWEEDIE, M.A., B.Sc., F.R.S.E., Lecturer on Mathe-  
matics, University, Edinburgh
- 185 DAVID TWEEDIE, M.A., B.Sc., Ministry of Public Instruction,  
Cairo, Egypt
- GEORGE D. VALENTINE, M.A., Advocate, 13 Pitt Street,  
Edinburgh
- ROBERT WALKER, M.A., Provincial Training College, Glasgow
- SAMUEL WALKER, M.A., D.Sc., George Heriot's School,  
Edinburgh
- A. G. WALLACE, M.A., F.R.S.E., Headmaster, Central Public  
School, Aberdeen
- 190 W. WALLACE, M.A., F.R.S.E., Moss-side P.O., Belvidere,  
Alberta, Canada
- T. P. WATSON, M.A., B.Sc., F.R.S.E., Principal, Technical  
College, Keighley, Yorkshire
- JOHN C. WATT, M.A., Jesus College, Cambridge
- JAMES MACPHERSON WATTIE, M.A., B.A., H.M.I.S., Linton,  
Strathern Road, Broughty-Ferry
- J. H. MACLAGAN-WEDDERBURN, M.A., D.Sc., 6 Succoth  
Gardens, Edinburgh (*Editor of Proceedings*)
- 195 JOHN WEIR, M.A., Professor of Mathematics, Mysore, India
- WILLIAM WELSH, M.A., Jesus College, Cambridge
- JOHN W. WHITE, B.A., Trinity Academy, Leith
- WM. WYPER, C.E., 10 Highbury Terrace, Dowanhill, Glasgow
- Rev. JOHN YOUNG, M.A., Whithorn, Wigtownshire
- 200 W. YOUNG, F.F.A., Actuary's Dept., New York Life Insurance  
Co., 346 Broadway, New York, U.S.A.

**The following Presents to the Library have been received, for which  
the Society tenders its grateful thanks:—**

1. American Journal of Mathematics.
2. Bulletin of the American Mathematical Society.
3. Proceedings of the American Philosophical Society.
4. Annals of Mathematics.
5. Proceedings of the Cambridge Philosophical Society.
6. Proceedings of the Royal Society of Edinburgh.
7. Bulletin de la Société Mathématique de France.
8. Journal de Mathématique Élémentaire.
9. Bulletin de la Société Physico-Mathématique de Kasan.
10. Mémoires de la Société Royale des Sciences de Liège.
11. Proceedings of the London Mathematical Society.
12. Revista de la Real Academia de Ciencias exactas, físicas y naturales de Madrid.
13. Memorias de la Real Academia de Ciencias exactas, físicas y naturales de Madrid.
14. Memoirs and Proceedings of the Manchester Literary and Philosophical Society.
15. Annales de la Faculté des Sciences de Marseilles.
16. Mathematical Gazette.
17. Nieuw Archief voor Wiskunde.
18. Rendiconti del Circolo Matematico di Palermo.
19. Annaes Scientificos da Academia Polytechnia do Porto.
20. Revue Semestrielle des Publications Mathématiques.
21. Proceedings of the Tōkyō Mathematio-Physical Society.
22. Nova Acta regiae Societatis Scientiarum Upsaliensis.
23. Prace Matematyczno-Fizyczne, Warsaw.
24. Bulletin of the Philosophical Society of Washington.
25. Wiskundige Opgaven met de Oplossingen.
26. Mathematisch-naturwissenschaftliche Mitteilungen im Auftrag des Mathematisch-naturwissenschaftlichen Vereins in Württemberg
27. Vierteljahrsschrift der Naturforschenden Gesellschaft in Zürich.
28. Vier Mathematische Abhandlungen von Sampachi Fukuzawa.
29. Poliseccion Grafica del Angulo, por el Coronel de Artilleria Don Isidoro Cabanyes.
30. Index du répertoire bibliographique des Sciences Mathématiques.
31. The motion of a solid in an infinite liquid, by Professor Sir A. G. GREENHILL.
32. The third elliptic integral and the ellipsotomic problem, by Professor Sir A. G. GREENHILL.
33. Teaching of Mathematics by familiar applications on a large scale, by Professor Sir A. G. GREENHILL.
34. The mathematical theory of the top considered historically, by Professor Sir A. G. GREENHILL.
35. The elliptic integral in electromagnetic theory, by Professor Sir A. G. GREENHILL.
36. The application of the elliptic functions, by Professor Sir A. G. GREENHILL.
37. Differential and integral calculus, by Professor Sir A. G. GREENHILL.
38. A treatise on hydrostatics, by Professor Sir A. G. GREENHILL.
39. Rendiconti del Circolo Matematico di Palermo, Vols. 1, 2, 3, presented by CHARLES TWEDDIE, M.A., B.Sc.
40. A history of accounting and accountants, edited and partly written by R. BROWN.
41. Obras sobre Mathematica do Dr F. GOMES TEIXEIRA.
42. Reale dell'Essere, l'Essere è il non Essere, by CAPITANO G. BORREDON.
43. Klassifikation der Unstetigkeiten von Funktionen enie reellen Veränderlichen, von Sampachi Fukuzawa.
44. Sopre una nuova espressione dell'ordine e della classe di una curva gobba algebrica, by M. G. B. GUCCIA.
45. Un théorème sur les courbes algébriques planes d'ordre  $n$ , by M. G. B. GUCCIA.



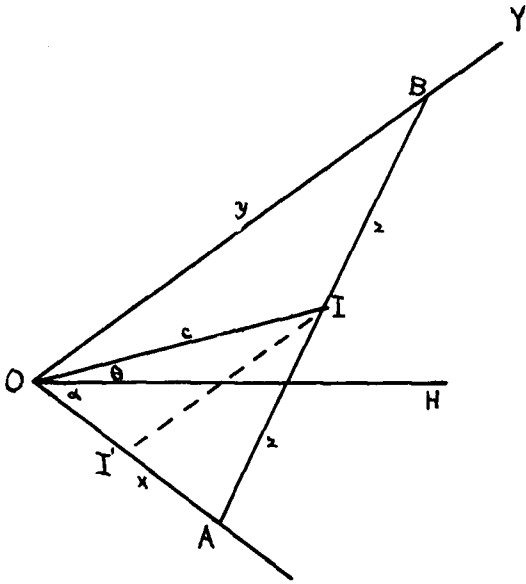

Fig. 1.

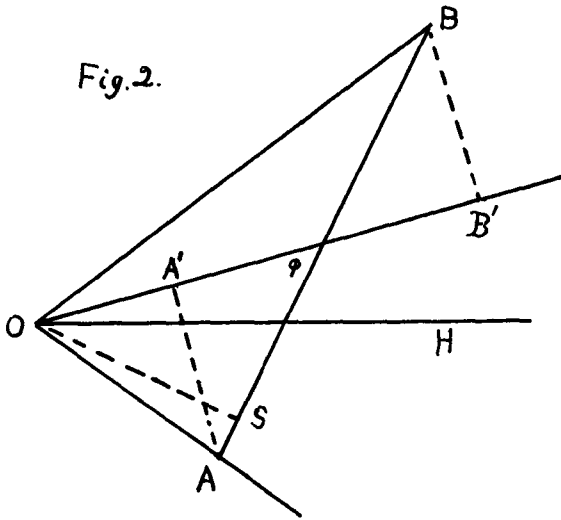

Fig. 2.

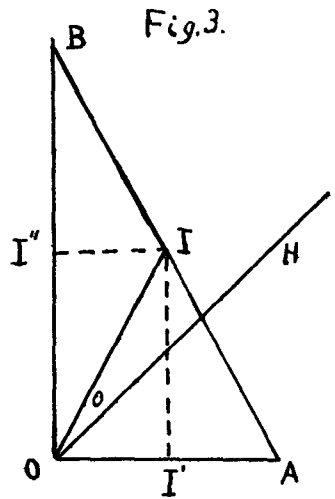

Fig. 3.

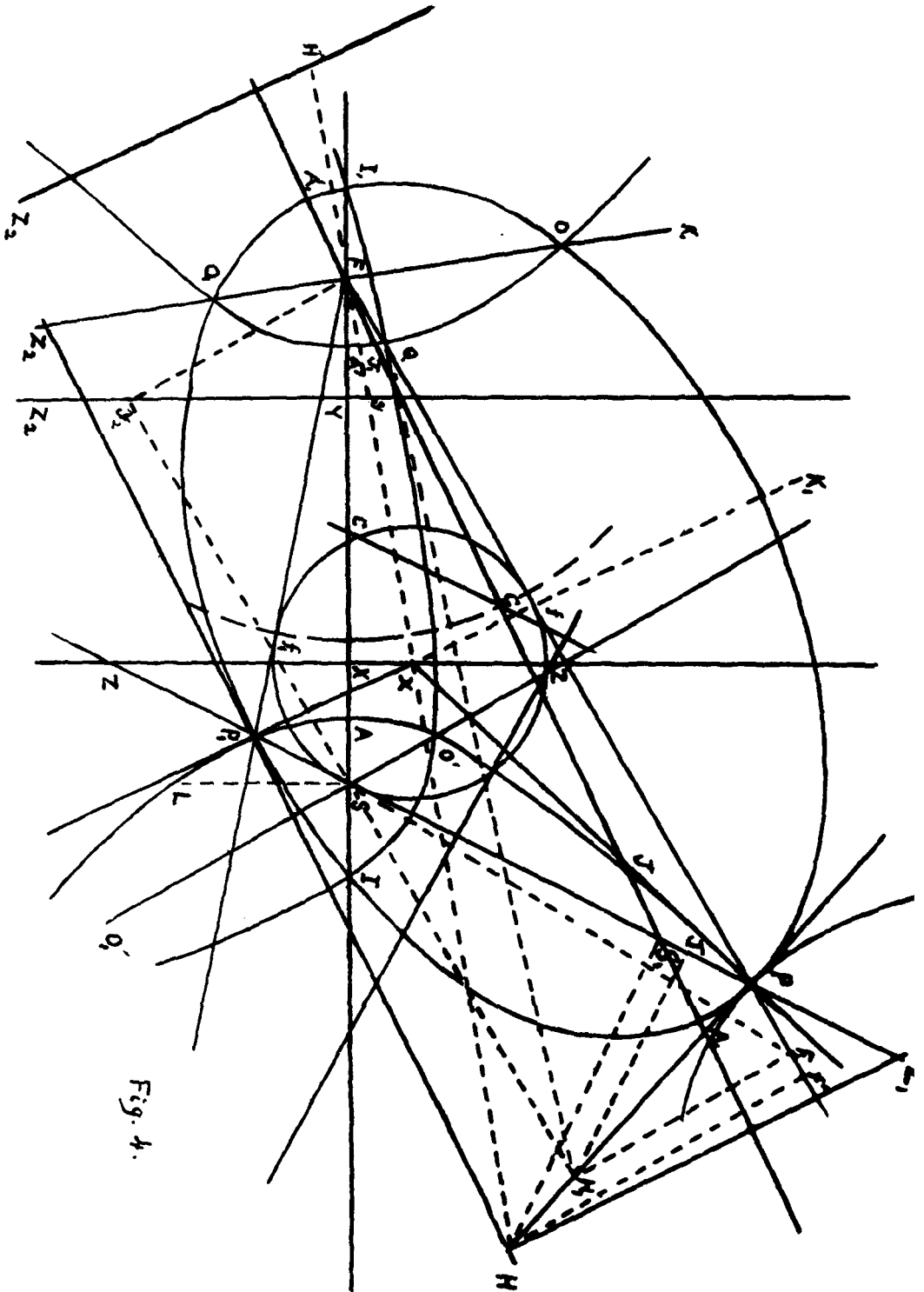

Fig. 4.

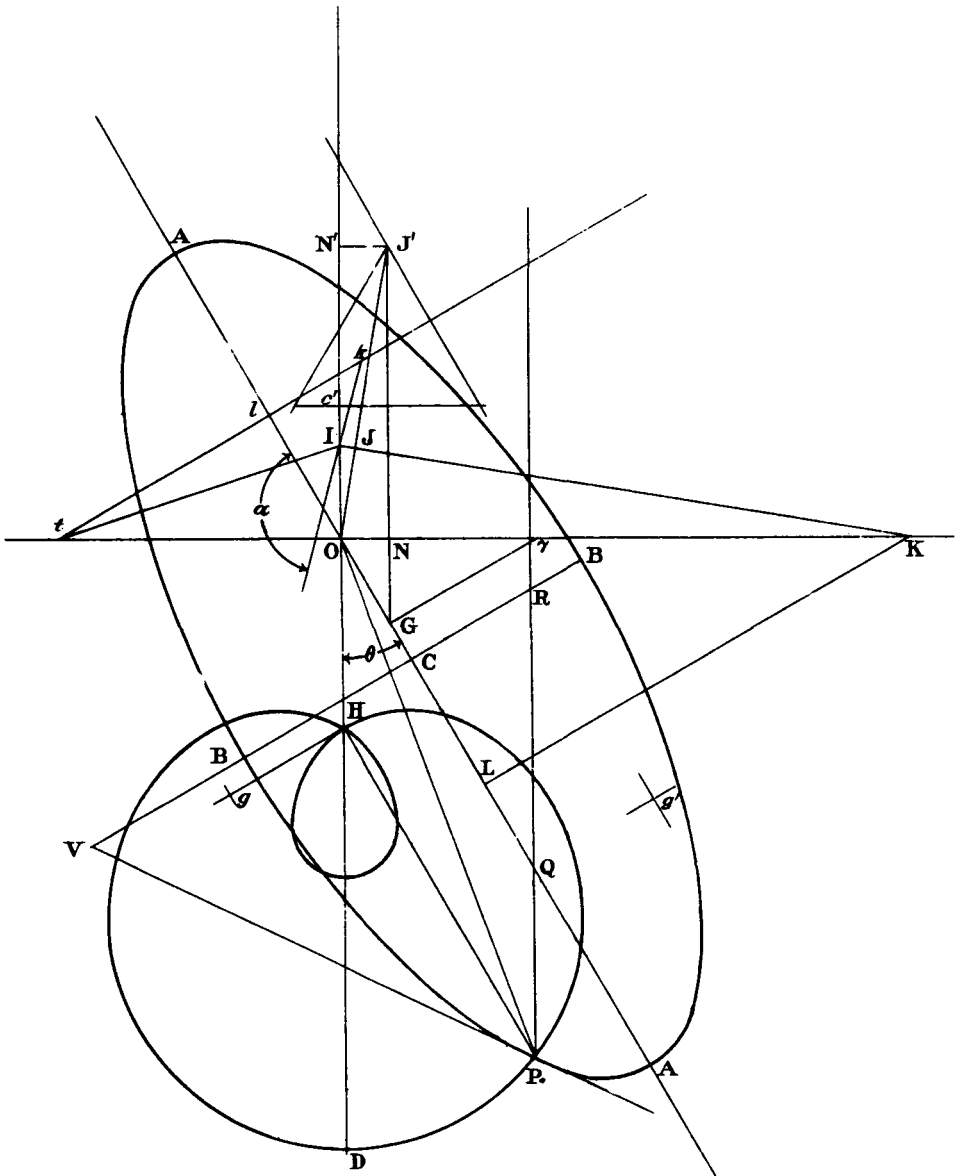
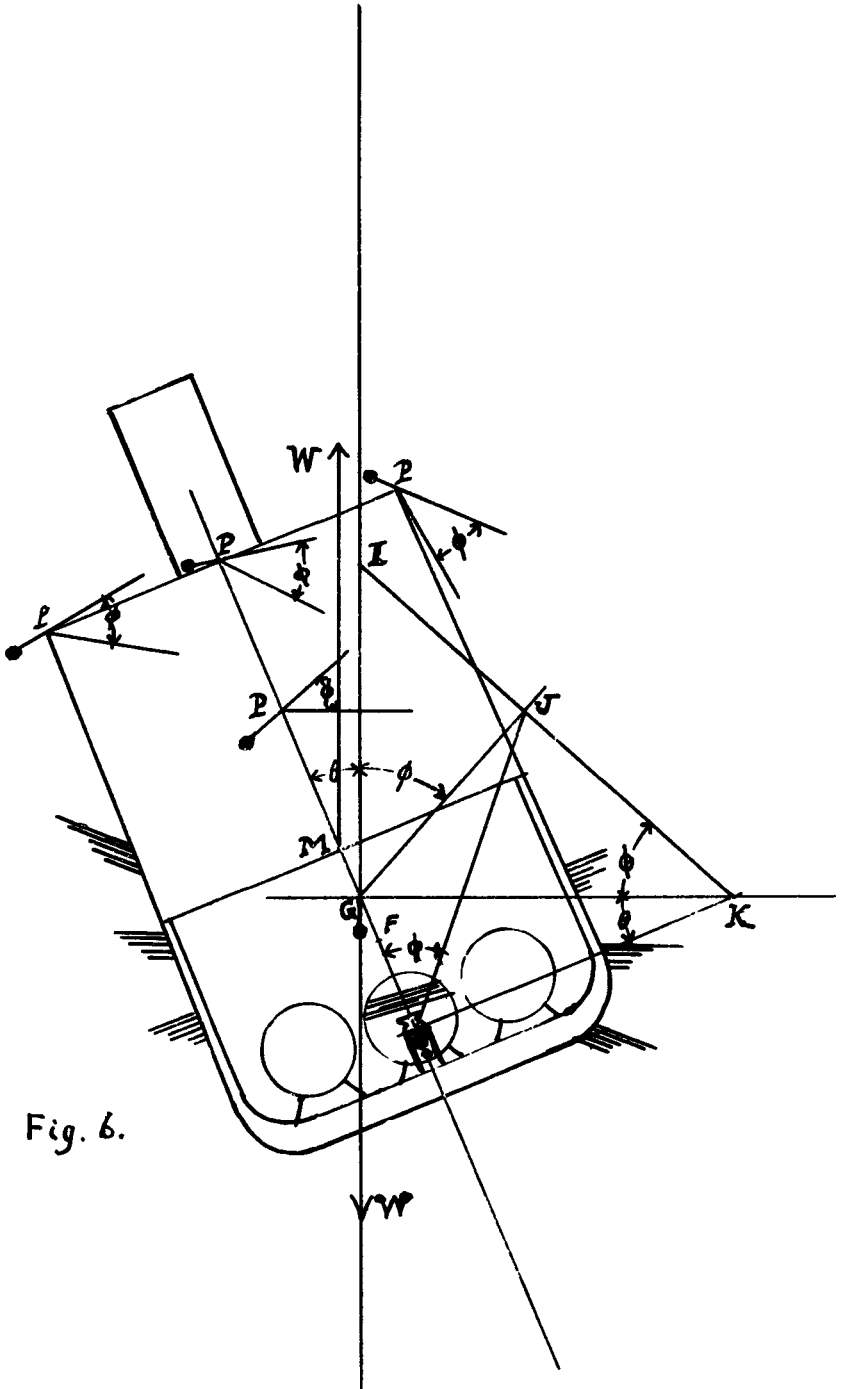

Fig. 5.



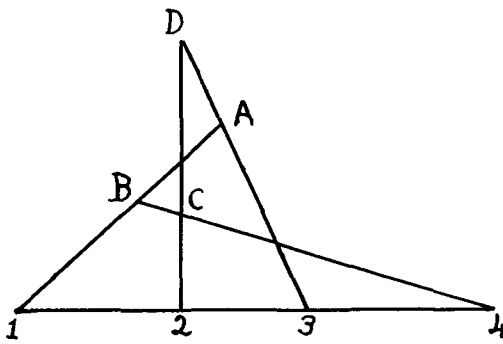

Fig. 7.

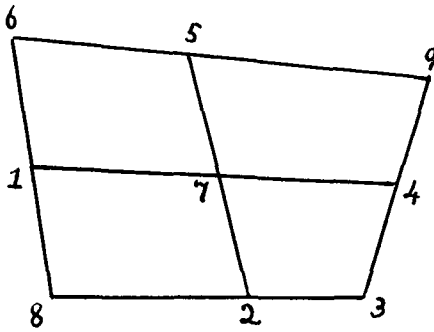

Fig. 8.

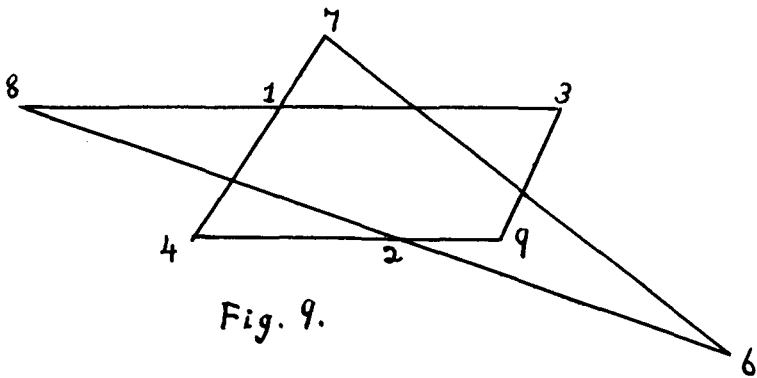

Fig. 9.

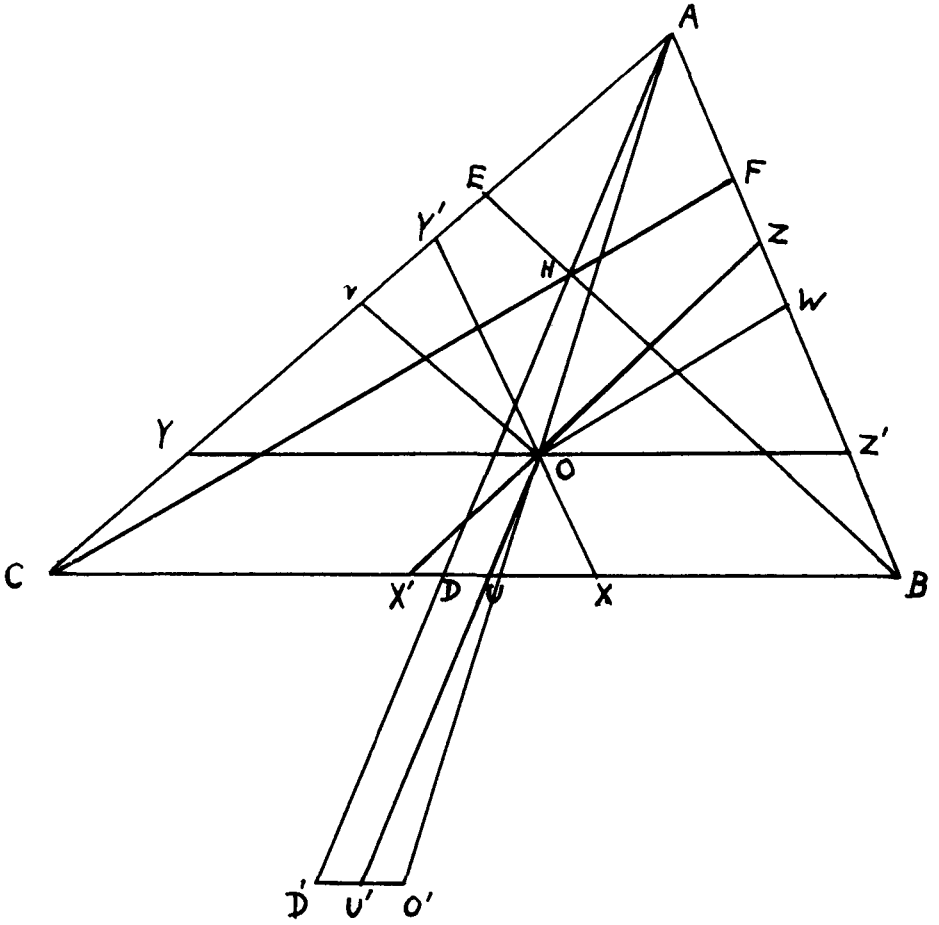

Fig. 10.

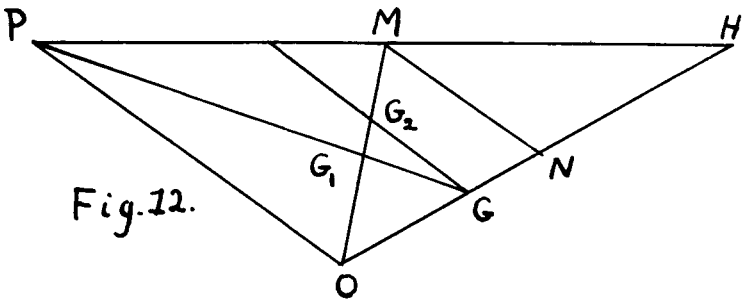
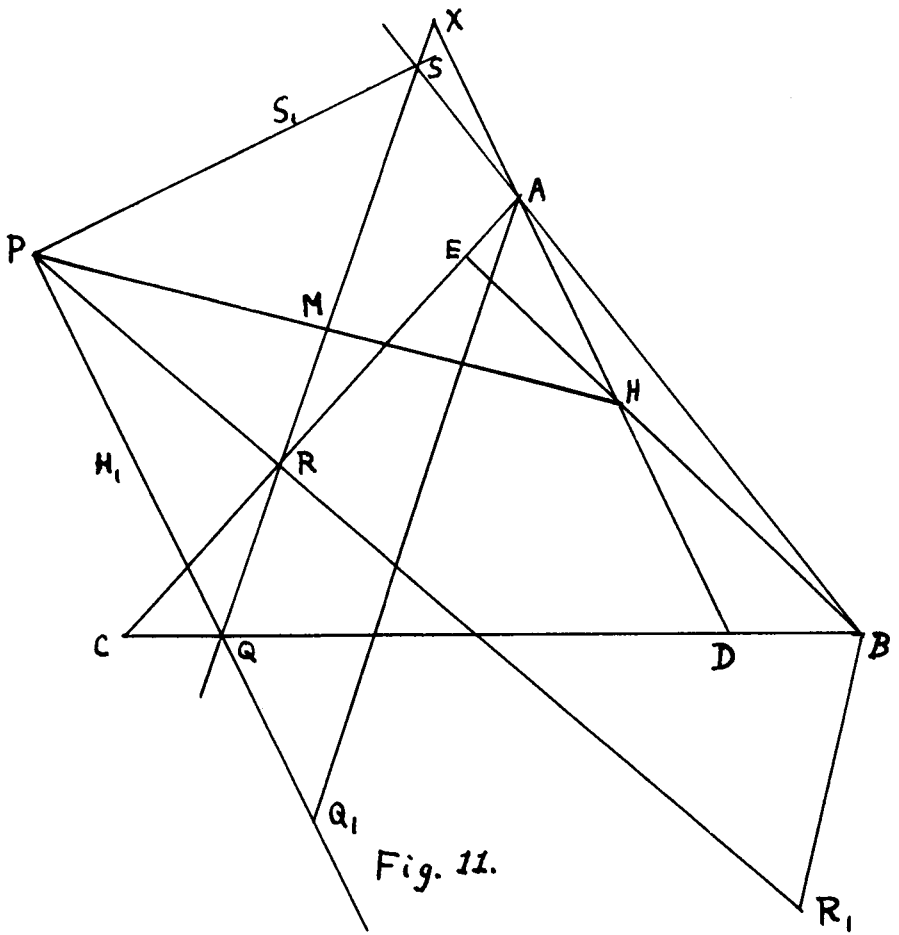

Fig. 13.

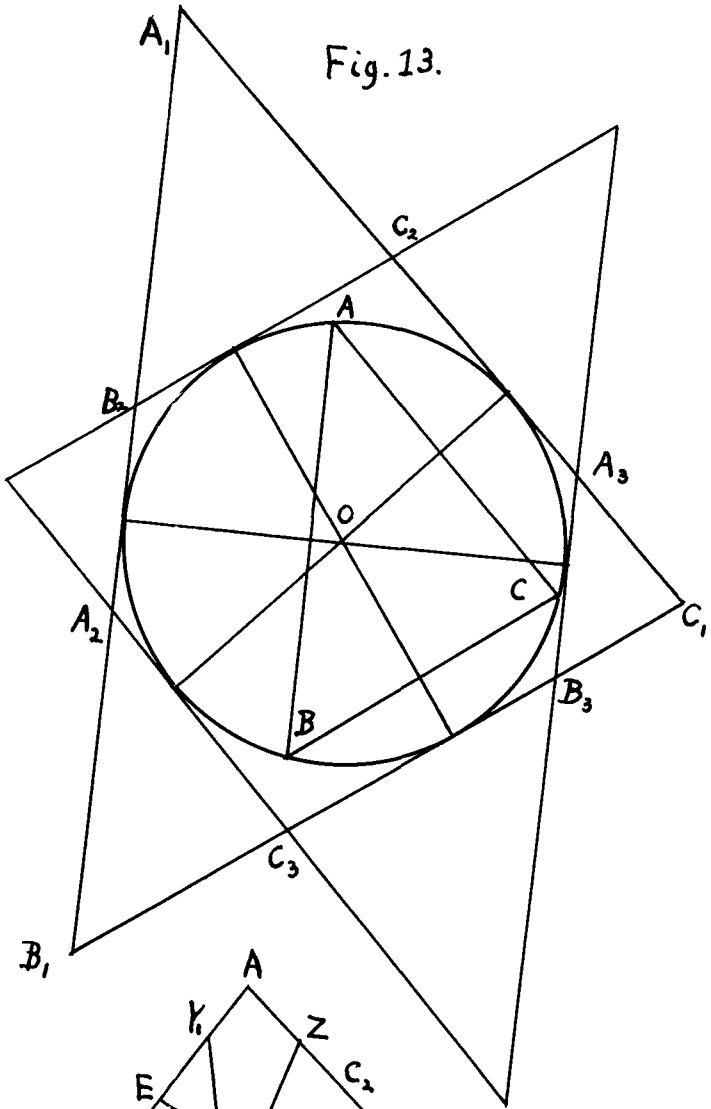

Fig. 14.

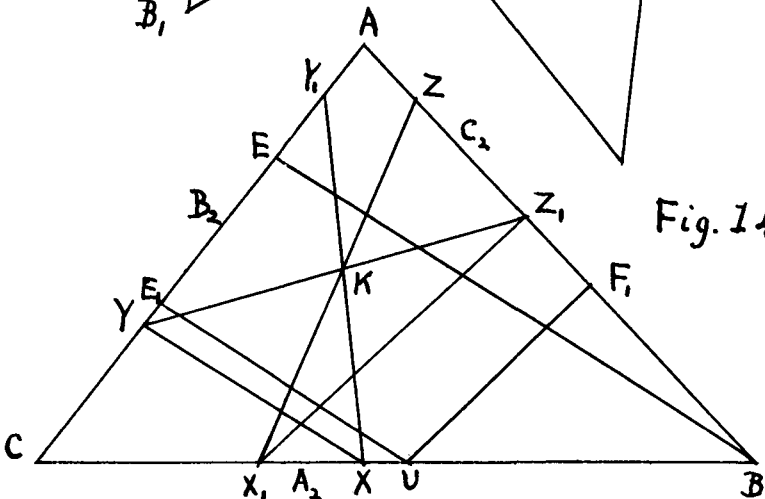



Fig.15.

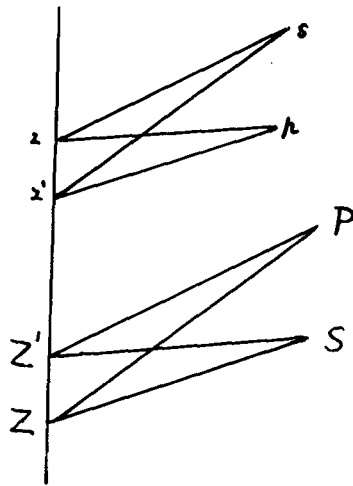

Fig.16.

