

EVOLUTION OF BENZYLAMMONIUM-VERMICULITE AND ORNITHINE-VERMICULITE INTERCALATES

C. DE LA CALLE,¹ M. I. TEJEDOR,² AND C. H. PONS³

¹ CSIC. Instituto de Ciencia de Materiales c/Serrano Serrano 113, 28006 Madrid, Spain

² Water Chemistry Program, University of Wisconsin–Madison, Wisconsin 53706 (USA)

³ Université d'Orléans, CRMD-Université (UMR 0131)-UFR Sciences, Rue de Chartres BP 6759
45064 Orléans Cedex 2, France

Abstract—This report consists of a study of l-ornithine hydrochloride-vermiculite and of benzylammonium hydrochloride-vermiculite complex. The evolution of these organo-vermiculite structures upon heating is studied by X-ray diffraction (XRD) as well as infrared spectroscopy.

After heating vermiculite saturated with l-ornithine cations, it shows condensation of interlayer ornithine molecules (peptide complexes). The stacking mode, opposing ditrigonal cavities, is not modified between aminoacid complex and peptide complex.

For vermiculite saturated with benzylammonium cations, the stacking sequence changes through heating by changing benzylammonium to NH₄⁺. This transformation implies a sliding of the layers over each other. The ditrigonal surface cavities become face to face, as in the original mica. There are no random translations as in the starting complex.

Key Words—Benzylammonium, Intercalate, IR, NIR, Order-disorder, Ornithine, Stacking order, Vermiculite, X-ray.

INTRODUCTION

The positions of adjacent 2:1 layers in vermiculites are controlled in part by 1) cation-dipole interactions; and 2) by hydrogen bonding between interlayer water molecules and the basal oxygen of the tetrahedral sheet. Thus, layer stacking sequences depend on the nature of the interlayer cation and the relative humidity, and are largely controlled by local charge balance (de la Calle and Suquet 1988). In the case of vermiculite, which has reacted with certain organic species, Slade et al. (1976, 1978, 1987), Slade and Raupach (1982), and Slade and Stone (1983, 1984) showed that stacking sequences may be ordered with the ditrigonal cavities of the tetrahedral sheets of adjacent layers opposing each other as in micas.

In this paper, we report on a qualitative single crystal XRD study of l-ornithine hydrochloride-vermiculite complex

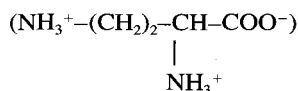

formed, at pH = 5.3, and of benzylammonium hydrochloride vermiculite ($\text{C}_6\text{H}_5\text{-CH}_2\text{-NH}_3^+$) formed at pH = 7. The transformation of these organo-vermiculite structures upon heating is studied by XRD using the methods of Weissenberg and precession photographs as well as infrared spectroscopy. This work is a continuation of the study of Slade et al. (1976), in which the authors describe a single layer polytype for ornithine-vermiculite (60°C dehydrated complex).

EXPERIMENTAL METHODS

Materials and Sample Preparations

The vermiculite used in this study is from Santa Olalla, Spain. The structural formula is: $(\text{Si}_{2.70}\text{Al}_{1.30})(\text{Mg}_{2.57}\text{Al}_{0.13}\text{Fe}_{0.26}\text{Mn}_{0.01})\text{O}_{10}(\text{OH})_2\text{Mg}_{0.45}\text{K}_{0.002}$. Santa Olalla vermiculite is formed from a mica, identified as a phlogopite, which results from the alteration of piroxenites (Gonzalez Garcia and Garcia Ramos 1960). The natural vermiculite was cut into flakes about $1 \times 2 \times 0.2$ mm and exchanged with 1 M NaCl solution for two weeks at 60°C. The solutions were changed daily, and the residual salt was removed by washing with deionized water.

ORNITHINE-VERMICULITE. Complexes are formed by immersing the Na-vermiculite single crystals in 0.5M aqueous solutions of l-ornithine hydrochloride at the pH of maximum charge (pH = 5.3) for 30 minutes. At this pH the carboxylate of the aminoacid is largely deprotonated:

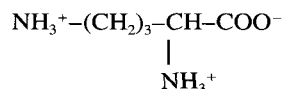

The proportion of the protonated form is 1000/1 (Mifsud et al. 1971). The exchange was repeated three times with fresh solutions to eliminate all interlayer Na⁺ ions.

Mifsud et al. (1971) report on the stability of different ornithine-vermiculite complexes at different temperatures. As the crystal is removed from the solution and allowed to dry at room temperature, the

original spacing of 4.22 nm undergoes a change. A whole sequence of distinct phases was observed by these authors. These are stable for only a few minutes, and correspond to different stages in the drying process. A phase of 2.20 nm finally develops, which is stable for about 3 h. Dehydration at 60°C for 14 h. results in a new phase of 1.63 nm that is stable at room temperature. Further dehydration at 220°C for 10 h. gives a complex of 1.45 nm that is also stable at room temperature.

In this paper, we study these ornithine-vermiculite samples, 1) after heating for 14 h. at 60°C, and 2) after heating for 24 h. at 240°C. In the first case we found a phase with a basal spacing of 1.63 nm. In the second case we found that the basal spacing had decreased to 1.46 nm.

BENZYLAMMONIUM-VERMICULITE. Flakes of Na-vermiculite were treated with 1 M aqueous solutions of benzylammonium-hydrochloride at pH = 7. The solution was changed daily for 15 days. The reaction was judged to be complete when a rational set of 001 reflections was observed based on 1.56 nm. The flakes were then washed until free of chloride. The crystal was removed from the water and allowed to dry at room temperature for a day. The rate of reaction between vermiculite and benzylammonium-hydrochloride was considerably slower than that between vermiculite and l-ornithine-hydrochloride.

Upon heating the benzylammonium-vermiculite for 24 h. at 300°C, we obtained a phase with a basal spacing of 1.03 nm. Samples of each complex (1.56 nm and 1.03 nm phases) were re-analyzed a number of times over a period of one month and were found to have both constant d-spacing and reflection patterns.

Methods

X-RAY DIFFRACTION. Intensity data were recorded with both Weissenberg and precession cameras using monochromatic CuK α radiation from a Rigaku rotating anode (at 10 kW power) generator. For 00 l reflections, intensity data between 2° and 100° 2 θ were recorded with a Siemens D-500 diffractometer with monochromatic CuK α radiation (40 kV and 20 mA). The divergent and receiving slits had respective openings of 1° and 150 μ m, and they allowed the sample to remain completely within the X-ray beam at all angles of 2 θ . An angular geometric correction (Brindley and Guillery 1956) was used, along with corrections in intensity for Lorentz, polarization, geometric and absorption factors (Martin de Vidales et al. 1990).

Two stable phases at room temperature, for both ornithine-vermiculite (1.63 nm and 1.46 nm) and benzylammonium-vermiculite (1.56 nm and 1.03 nm) complexes were examined by Weissenberg and precession methods (levels (hOl), (OkI), (1kI)). A quali-

tative analysis of these levels lead to the following conclusions:

1) If all the levels yield only discrete reflections, one has an ordered phase. It is well known that phlogopites show two types of ordered stacking; one example (1M) is very common, the other (2M₁) much rarer (Bailey 1985). In both cases, the pseudo-hexagonal cavities on the surface of adjacent layers face each other and enclose the interlayer K cations. De la Calle and Suquet (1988) show that Santa Olalla phlogopite has the 1M polytype stacking order. In some rare hydrated states Santa Olalla vermiculite reproduces this ordered stacking. On the cases that were studied by de la Calle and Suquet (1988), ordered stacking could only be obtained if the interlayer material determined, unequivocally, the relative position of the layers. As with phlogopites, this type of stacking occurs when the pseudo-hexagonal cavities in adjacent layers are opposite each other. In this case, the average structure can be described using classic crystallographic methods;

2) If certain discrete reflections lying along rows parallel to Z* (levels (OkI) and (1kI)) are replaced by diffuse streaks, the phase is partially-ordered (de la Calle and Suquet 1988). In this paper, we will be only concerned with so called planar disorder due to layer translations in the plane of the layer. The structure of one vermiculite will be called semi-ordered when, in a pile of M layers, the passage from the n th layer to the ($n + 1$)th in the Y direction can be made by means of two or more different translations. The translations along X and Z are always unequivocal ($-a/3$ and d_{001}). For semi-ordered stacks, the reciprocal space cannot be described by a set of $hk l$ reciprocal spots (h, k, l integers) but by modulated reciprocal rods (h, k) with a continuous variation of intensity along the rods that depends on the nature of the two-dimensional structural units and the way they are stacked (Mering 1949; Guinier 1964; de la Calle et al. 1993). The rods are cylinders of infinite length with a small basal area centered on the hk nodes of the reciprocal lattice of the two dimensional structural units and perpendicular to the plane of this lattice. For a semi-ordered vermiculite, an examination of the Weissenberg and precision photographs containing the intensity distribution along the ($h, 0$), ($0, k$) and ($1, k$) reciprocal rods show they fall into two groups: 1) those containing sharp diffraction spots; and 2) those containing more-or-less diffuse bands. Generally, the rods of the ($h0l$) level are discrete. The ($0, k$) and ($1, k$) rods may be classified as discrete ($k = 3n$), more-or-less diffuse, or diffuse ($k \neq 3n$) (de la Calle and Suquet 1988).

INFRARED SPECTRA. The DRIFTS spectrum of the air dried and heated benzylammonium-vermiculite was recorded with a Nicolet 60SX Fourier transform infra-

Ornithine-vermiculite after heating at 60°C

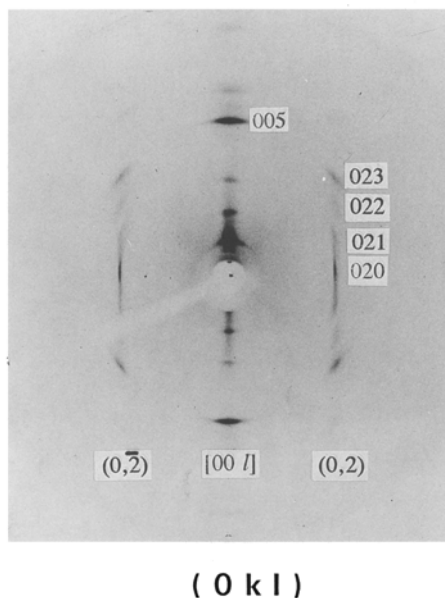

Ornithine-vermiculite: after heating at 240°C

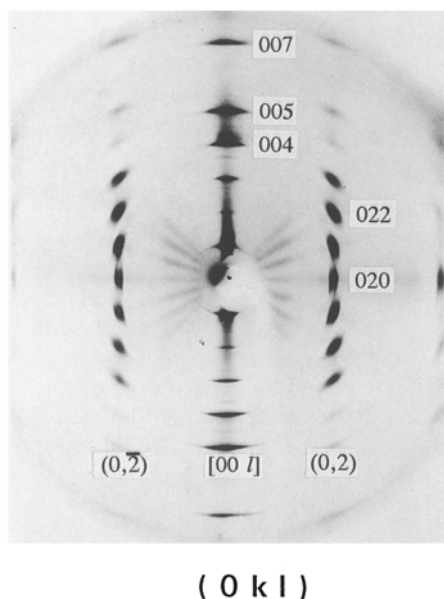

Figure 1. $(0kl)$ precession nets of l-ornithine-vermiculite: dehydrated at 60°C (1.63 nm) and after heating at 240°C (1.46 nm).

red spectrophotometer and a broad range MCT detector. The diffuse reflectance accessory was a Spectra Tech design (the COLLECTOR).

The spectrum is the result of rationing the single beam spectrum of a mixture of vermiculite and KCl. Then, the Kubelka-Munk equation is applied to the resulting transmittance spectrum. The single beam spectra was the result of 1000 coadded interferograms at a resolution of 4 cm^{-1} . Happ-Genzel apodization was used.

RESULTS AND DISCUSSION

X-Ray Results

STACKING MODE OF L-ORNITHINE-VERMICULITE. We document two vermiculite structures (1 and 2) saturated with l-ornithine, with basal spacings of 1.63 nm and 1.46 nm. These structures were previously studied by one-dimensional Fourier analysis normal to $[00l]$ (Rausell-Colom and Fornes 1974). 1) Vermiculite obtained by dehydration at 60°C. Slade et al. (1976) described the arrangement of interlayer organic molecules of a 1.63 nm phase of ornithine vermiculite by Fourier analysis. This study showed that ornithine-vermiculite forms a one-layer polytype. Likewise, Figure 1 shows that the 1.63 nm phase of ornithine-vermiculite synthesized here corresponds also to a one-layer ordered structure with opposing ditrigonal cavities (aOz and bOz ordered projections, all reflections are discrete).

2) Vermiculite heated at 240°C. A stable phase with a basal spacing of 1.46 nm was studied, Figure 1 shows the precession $(0kl)$ level ((00) and (02) discrete rods). All reflections are discrete like the 60°C dehydrated complex and the structure also corresponds to a 1M polytype. Preliminary infrared absorption studies (de la Calle and Pons, unpublished data) suggests that this complex is analogous to the diketopiperazine condensation reaction as studied by Fornes et al. (1974) for a peptide vermiculite complex.

Note the difference in the rod appearance (Figure 1 e.g. $k = 2$) between the 60°C dehydrated complex and the 240°C heated complex. Figure 1 shows rods with some streaking between Bragg spots that is not present in the high-temperature complex. This streaking is the result of a proportion of small, random translations parallel to the Y axis (Mering 1949). We conclude that, the peptidic condensation "cures" these faults and produces a more ordered arrangement.

STACKING MODE OF BENZYLAMMONIUM-VERMICULITE. On this case we also study two samples (1 and 2) in which one was air dried and the other heated to 300°C. 1) Air dried: the precession X ray pattern (Figure 2) shows that the 1.56 nm phase of benzylammonium-vermiculite synthesized here corresponds to a partially-ordered vermiculite with diffuse streaks in level $(0kl)$. Weissenberg patterns (Figure 3) show that the

Benzylammonium-vermiculite Air Dry

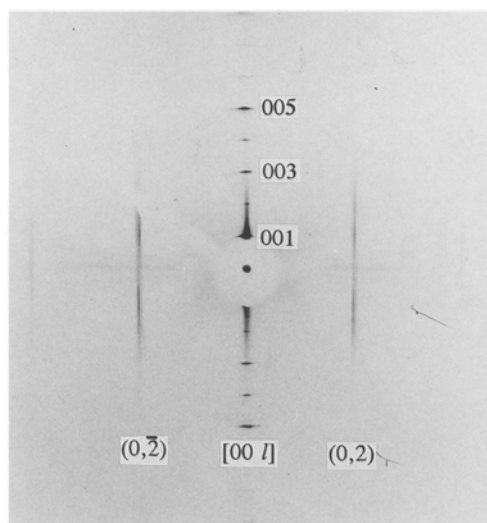

(0 k l)

Benzylammonium-vermiculite: after heating at 300°C

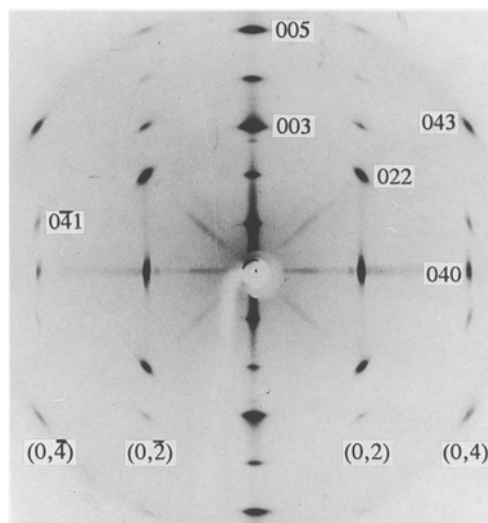

(0 k l)

Figure 2. (0kl) precession photographs of benzylammonium-vermiculite: air dried (1.56 nm) and after heating at 300°C.

(h, 0), (0, k) and (1, k) reciprocals rods may be divided into two groups; the group of (h, 0), (0, 6), (1, 3) and (1, 9) (e.g. $k = 3n$) rods with sharp diffraction spots and the group of (2, 0), (1, 1), (1, 5) and (1, 7) (e.g. $k \neq 3n$) rods where the intensities are diffuse. Thus, the specimen has an ordered structure in the (aOz) projection and a disordered structure in the (bOz) projection similar to original Santa Olalla vermiculite (de la Calle et al. 1988). The layer stacking is characterized by translation faults $+b/3$ and $-b/3$ which are random by shifts along the Y direction (Mering 1949; de la Calle and Suquet 1988).

The one-dimensional Fourier projection of the structure onto [00l] was made using the first 15 00l reflections (Figure 4). The basal spacing of the samples was taken as 1.565 nm. Phases for the 00l diffraction spots were obtained from the known configuration 2:1 layer and assigned to the structure amplitudes. The observed and the calculated one-dimensional projections ($R = 6\%$) are compared in Figure 4. Atomic parameters were allowed to vary. Table 1 lists the final atomic parameters.

2) After heating at 300°C: precession (Figure 2) and Weissenberg photographs (Figure 3) show discrete reflections for this sample. Thus, the stacking mode is ordered, thereby producing three-dimensional diffraction structure. This structure corresponds to the 1M polytype of the original phlogopite. The pseudo-hexagonal surface cavities oppose each other on either side of the interlayer material. The three-dimensional order is most likely related to the presence of NH_4^+ in the interlayer. Like anhydrous K, Rb, Cs and Ba vermiculites (de la Calle and Suquet 1988), the NH_4^+ is located in the center of the ditrigonal cavities of adjacent layers (see infrared results).

Infrared Results on Benzyl Ammonium Vermiculite

IR spectra of two benzylammonium-vermiculite samples, which were dried in air and heated to 300°C are shown in Figure 5, and the corresponding band assignments are given in Table 2. The purpose of this study is to establish: 1) whether the dried air sample changes to NH_4 -vermiculite upon heating at 300°C; 2) the hydrogen bonding properties of the potentially produced NH_4^+ ions (its relative strength and symmetry); and 3) whether or not there is molecular water in the heated sample and how these water molecules interact with the NH_4^+ .

TRANSFORMATION ON HEATING. A comparative study of the spectra of Figure 5 reveals that upon heating, the bands (see Table 2) (Noel 1994) are no longer present in the spectrum due to the benzene ring and the $-\text{CH}_2-\text{NH}_3$ group. Moreover, the spectrum of the heated sample (Figure 5b) shows new absorption in the neighborhood of 3120 cm^{-1} and at 1415 cm^{-1} . These bands are characteristic of the ammonium ion (Nakamoto

**Benzylammonium-vermiculite:
Air Dry**

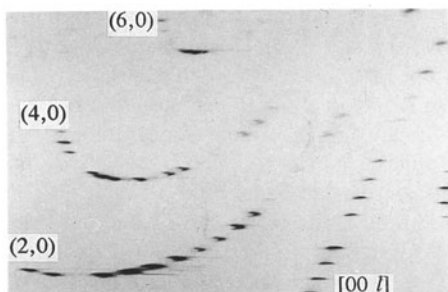

(h 0 l)

**Benzylammonium-vermiculite:
after heating at 300°C**

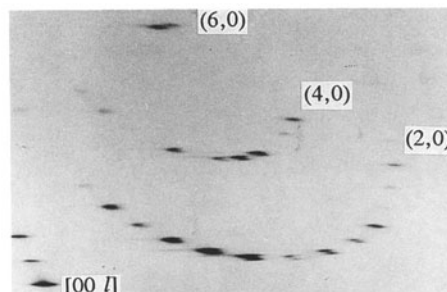

(h 0 l)

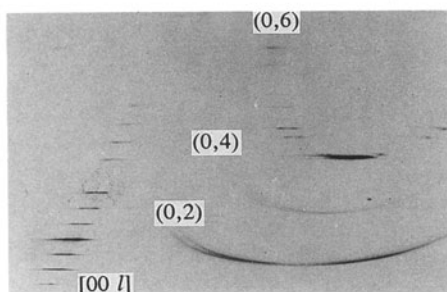

(0 k l)

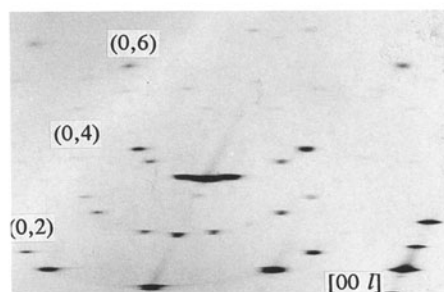

(0 k l)

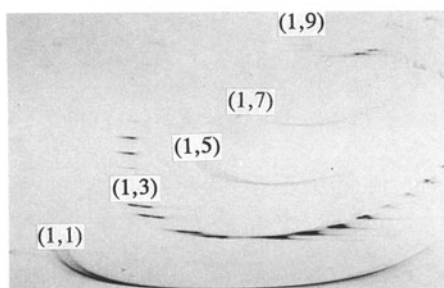

(1 k l)

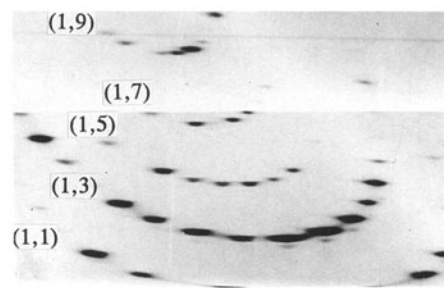

(1 k l)

Figure 3. (h0l) (0kl) and (1kl) Weissenberg photographs of benzylammonium-vermiculite: air dried (1.56 nm) and after heating at 300°C. [hk l] with (h + k) = 2n.

1986) (see Table 2). Hence, the IR data indicates that the heating of the benzylammonium vermiculite at 300°C produces the thermal degradation of the benzylammonium ions. This degradation results in the formation of ammonium ions that remain with the vermiculite.

H-BONDING PROPERTIES OF NH₄⁺ IONS IN VERMICULITE. *Relative Strength.* The analysis will be based on: 1)

the generally accepted rule that hydrogen bonding will depress the stretching frequency of NH₄⁺ and will increase the frequency of its bending mode (Cotton and Wilkinson 1988; Yamamuchi and Kondo 1988); 2) the comparison of the spectrum of ammonium in vermiculite with the spectra of NH₄⁺ in environments for which there is some knowledge about its hydrogen bonding properties. In this paper we will evaluate the

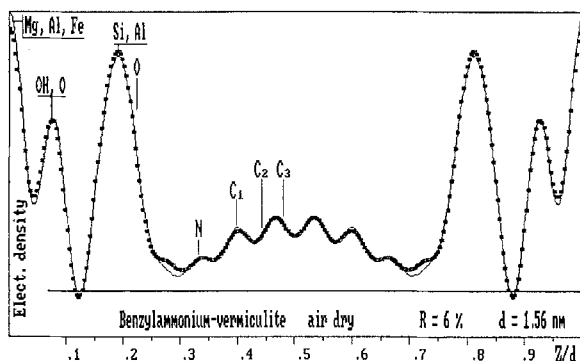

Figure 4. One-dimensional Fourier synthesis from 00 l diffraction intensities of air dried benzylammonium-vermiculite ($d_{001} = 1.565$ nm). — calculated and observed values.

hydrogen bonding properties of NH_4^+ in vermiculite in relation with the ones of NH_4^+ in I^- , Cl^- , and Br^- lattices, as well as in H_2O solution. In the I^- lattice, the NH_4^+ forms very weak hydrogen bonds with I^- ions and the T_d symmetry is maintained. In an aqueous solution, the ammonium ion should form stronger hydrogen bonds than in any of the halide lattices since N and O are first-row elements, and furthermore in an aqueous solution, the electronegative atoms have more mobility than in a crystal lattice (Cotton and Wilkinson 1988). In the spectra of NH_4^+ in halides the doublet corresponding to the coupling of $\nu_3(\text{F}_2)$ with $\delta_d(\text{E}) + \delta_d(\text{F}_2)$ modes which is predominantly a stretching vibration, appears at $3145\text{--}3022$ cm^{-1} in I^- , at $3138\text{--}3044$ cm^{-1} in Cl^- and at $3137\text{--}3031$ cm^{-1} in Br^- (Yamamuchi and Kondo 1988). The bending mode, $\delta_d(\text{F}_2)$, is observed near 1390 , 1403 and 1401 cm^{-1} for I^- , Cl^- and Br^- respectively. In the spectrum of NH_4^+ in H_2O (see Figure 6 and Table 3), the stretching modes are observed at lower wavenumbers ($3035\text{--}2900$ cm^{-1}) than in the spectra of this ion in halides, while the bending mode appears at higher energy values (1452 cm^{-1}). This shows that IR spectroscopy has sufficient resolution to illustrate the differences in the length of the hydrogen bonds NH_4^+ in these two types of matrices. Hence, this technique should be able to provide information on the degree of association of the NH_4^+ ion in vermiculite.

Bands due to the stretching mode, $\nu_3(\text{F}_2)/\delta_d(\text{E}) + \delta_d(\text{F}_2)$, of NH_4^+ ions in vermiculite (Figure 6c), are observed, as part of an unresolved structured absorption envelope ($3232\text{--}2700$ cm^{-1}). Other chemical groups present in the sample, as hydrogen bonded OH^- and H_2O , may contribute to the absorption in this region (see Table 3), and hence they may bias the exact position of the absorption bands assigned to the NH_4^+ . However, the bending mode, $\delta_d(\text{F}_2)$ of NH_4^+ in vermiculite is clearly observed at 1416 cm^{-1} . This value is lower than that of the corresponding mode in

Table 1. Atomic parameters for Benzylammonium-vermiculite (air dried).

Atom	$z(\text{\AA})$	m	$B(\text{\AA}^2)$
Tetrahed. cat.			
Si	2.720	2.704	1.5
Al	2.720	1.296	1.5
Octahed. Cat.			
Mg	0.000	2.572	1.5
Al	0.000	0.133	1.5
Fe^{3+}	0.000	0.263	1.5
Ti^{4+}	0.000	0.017	1.5
Hydroxyl			
OH	0.920	2.000	1.5
Oxygen			
O1	1.140	4.000	1.5
O2	3.320	4.000	1.5
O3	3.200	2.000	1.5
Interlayer			
N	5.200	0.980	5.0
C1	6.200	2.940	5.0
C2	7.130	1.960	5.0
C3	7.490	1.960	5.0
H1	4.600	2.940	5.0
H2	5.500	1.960	5.0
H3	6.200	1.960	5.0
H4	6.650	0.980	5.0
H5	7.130	1.960	5.0

m = Multiplicity.

B = Temperature factor.

H_2O solution (1450 cm^{-1}) but higher than for the one in the halides ($1390\text{--}1403$ cm^{-1}). Thus, the IR data indicates that the ammonium ions form stronger hydrogen bonds with the vermiculite than those with the halides, but weaker bonds than with the water molecules in aqueous solution.

Symmetry of the NH_4^+ Tetrahedron. H-bonding not only increases the frequency of the absorption band due to the $\delta_d(\text{F}_2)$ mode of NH_4 but it will as well broaden it (George and McIntyre 1987). However, a com-

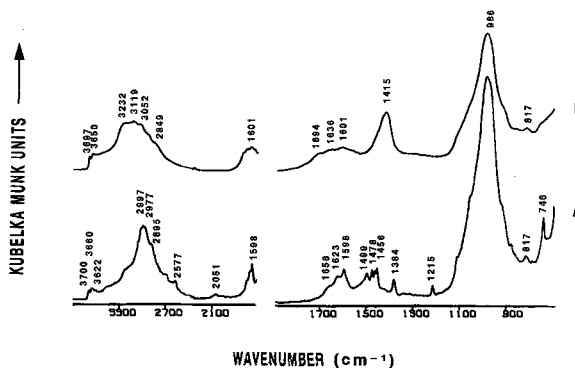

Figure 5. Infrared spectra: a) air dried; and b) heated benzylammonium-vermiculite.

Table 2. Infrared frequencies and band assignments for benzylammonium vermiculite.

Frequencies at maximum (cm ⁻¹)		Band assignment
Untreated sample	Sample heated at 300°C	
3700, 3660	3697, 3650	unassociated νOH
3622		unassociated νOH
3475	3600–3400	associated νOH/νH ₂ O
	3232	NH ₄ ⁺ combination band
	3119, 3052	ν _d /δ _d (E) + δ _d (F ₂) NH ₄ ⁺
3200, 2997		ν _a NH ₃ ⁺
2977		ν _s NH ₃ ⁺
2895		ν _s CH ₂
	2849	overtone of δ _d (F ₂) NH ₄ ⁺
2693, 2577		overt./comb. Benz.Ammo.?
	1694, 1600	δ _d (E), δ' _d (F ₂) NH ₄ ⁺ distorted tetrahedron
	near 1630	δH ₂ O
1658, 1623		δ _a , δ' _a NH ₃ ⁺
1598		ν Ph ring (mode 8)
1499 n.pk.		ν Ph ring (mode 19)
1499 b.bd		δ _s NH ₃ ⁺
1478–1456		δ CH ₂ /ν Ph ring (mode 19)
	1415	δ _d (F ₂) NH ₄ ⁺
1384		ω CH ₂ /ν Ph ring (mode 14)
1215		ω Ph-CH ₂ NH ₃ ⁺
986	986	Vermiculite modes
746		δ pH

¹ n. pk. = narrow peak.

² b.bd. = broad band.

³ Ph = Phenyl group.

parative analysis of the three spectra in Figure 6 shows that the band width of this mode of NH₄ in vermiculite is larger than the one expected from the value of its frequency. In addition, the spectrum of this ion in vermiculite shows a broad absorption triplet at 1694, 1646 and 1601 cm⁻¹. This triplet is absent from the other two spectra of Figure 6. These two observations suggest the formation of unequal hydrogen bonds by the four H atoms of the interlamellar NH₄⁺. When the NH₄⁺ ions are distorted to a lower than T_d symmetry

structure, both the ν₃(F₂) and δ_d(F₂) modes may split into two or three bands, and the modes ν_s(A₁) and δ_d(E) will become IR active yielding new absorption bands (Nakamoto 1986). Hence, a reduction in symmetry of the ammonium tetrahedron may as well be an explanation for the broadening of bands in the stretching region. The width of this band was difficult to explain, even admitting that some water is present in the sample.

THE PRESENCE OF MOLECULAR WATER IN AMMONIUM VERMICULITE AND ITS INTERACTION WITH THE NH₄⁺ IONS. The presence of molecular water in a sample could be distinguished from that of hydrogen bonded OH groups by studying the bending region of H₂O from the IR spectrum. The hydroxy group lacks the HOH bending mode near 1620 cm⁻¹. However, a distorted ammonium tetrahedron will absorb as well in this region; hence its presence in the sample will not allow us to

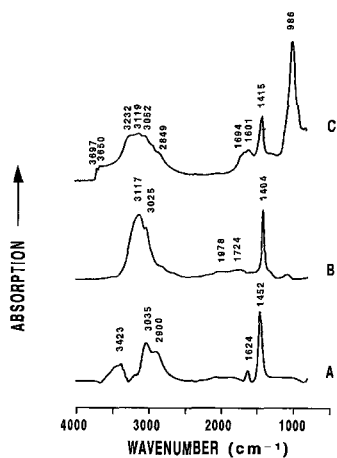

Figure 6. Infrared spectra NH₄⁺ ions in: a) water solutions; b) lattice of alkali halides; and c) heated benzylammonium-vermiculite.

Table 3. Infrared frequencies and band assignment for NH₄⁺ in different environments.

Frequencies at maximum (cm ⁻¹)		
Chloride salt	Aqueous solution	Assignment
	3423	ν _d /ν _s H ₂ O
3117, 3025	3035, 2900	ν _d /δ _d (E) + δ _d (F ₂)
1978	2050	δ _d (E) + ν ₆
1724	1835	δ _d (F ₂) + ν ₆
	1624	δ H ₂ O
1404	1452	δ _d (F ₂)

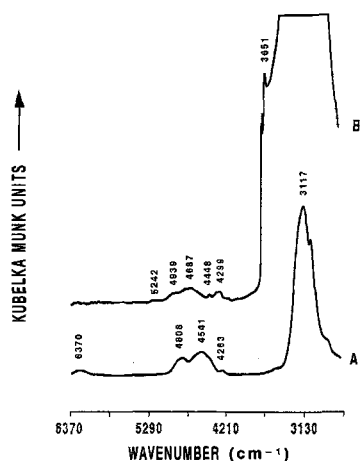

Figure 7. Infrared spectra of a) heated benzylammonium-vermiculite; and b) dry NH_4Cl in the NIR region.

make the above mentioned differentiation. Another possibility is to study the near infrared region, where the combination modes $\nu_{\text{as}}(\text{H}_2\text{O}) + \delta(\text{H}_2\text{O})$ and $\nu(\text{OH}) + \delta(\text{HO})$ absorb (5500 to 4000 cm^{-1}). In this region, the H_2O should exhibit a band between 5300 and 5180 cm^{-1} , and the hydroxyl group in the neighborhood of $4500\text{--}4000\text{ cm}^{-1}$ (Yamamuchi and Kondo 1988). Figure 7 shows the spectra of vermiculite (Figure 7A) and dry NH_4Cl (Figure 7B) in the NIR region. A comparative analysis of these two spectra suggests that the doublet at $4909\text{--}4700$ in the spectrum of vermiculite should be assigned to the combination band of NH_4^+ ; the peaks at 4446 and 4300 cm^{-1} correspond to hydroxyl groups; and a very weak and broad band, at $\approx 5209\text{ cm}^{-1}$, could be due to hydrogen bonded H_2O . Hence, from the NIR data we conclude that the ammonium vermiculite contains a small quantity of water.

In order to evaluate how much this water disturbs the structure of the NH_4^+ in vermiculite, the sample was subjected to a vacuum for 12 h. at room temperature. In the spectrum of this evacuated sample, the 5209 cm^{-1} peak is no longer visible. Furthermore, the absorption centered around 3400 and 1630 cm^{-1} decreases and the doublet at $3119\text{--}3050\text{ cm}^{-1}$ shifts to $3115\text{--}3038\text{ cm}^{-1}$. The rest of the spectral features remain unchanged, showing that the water present in the ammonium vermiculite is not influencing, to any detectable degree, the spectrum of the ammonium ions. Hence, the hydrogen bonding properties of NH_4^+ in vermiculite, extracted from its IR spectrum, are unrelated to the presence of molecular H_2O in the sample.

CONCLUSION

For vermiculite saturated with l-ornithine cations, the observed condensation of interlayer ornithine molecules is controlled by the 2:1 layers in this structure. These organic cations require the 2:1 layers to main-

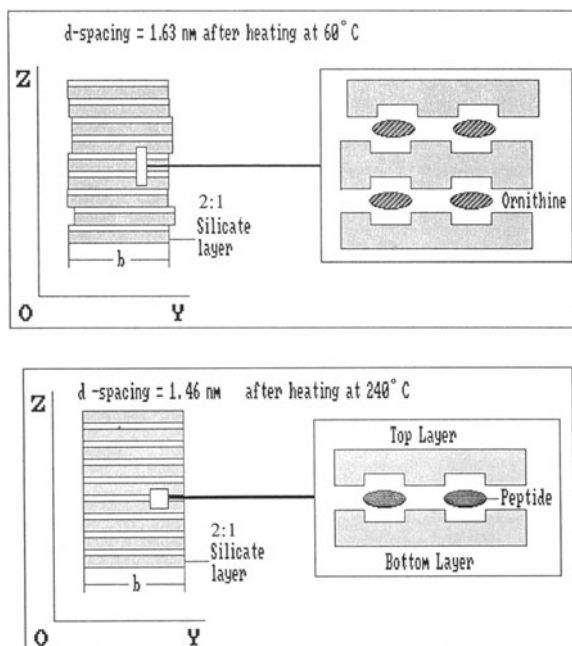

Figure 8. Evolution of l-ornithine-vermiculite stacking by heating at 240°C .

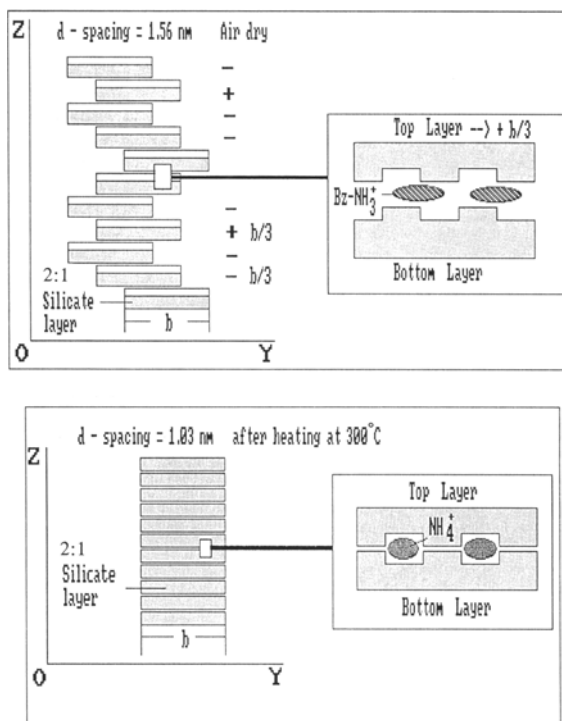

Figure 9. Evolution of benzylammonium-vermiculite stacking by heating at 300°C .

tain a sequence where the ditrigonal cavities oppose each other across the interlayer. This linkage produces the closest-packed ornithine groups favorable to peptide formation (Fornes et al. 1974). The stacking mode (opposing ditrigonal cavities) is not modified between the 60°C complex (aminoacid complex) and the 240°C complex (peptide complex). However, streaking between Bragg reflections is decreased, suggesting that stacking has become more regular at 240°C by decreasing the quantity of small, random translations parallel to the Y axis. Figure 8 provides a summary of the stacking evolution of l-ornithine-vermiculite which has been heated to 240°C.

For vermiculite saturated with benzylammonium, the stacking sequence changes as is observed by changing benzylammonium to NH_4^+ through heating to 300°C. The transition between the two phases (1.56 nm to 1.03 nm) implies a sliding of the layers over each other. Infrared data suggests that interlayer water is practically removed and that the NH_4^+ interlayer cation form hydrogen bonds with OH ions in the vermiculite 2:1 layer. Vibrations of OH groups are perturbed by the electric field of these monovalent cations which are positioned directly over OH groups in the anhydrous state. The ditrigonal surface cavities become face to face, as in the original mica. There are no random translations $+b/3$ and $-b/3$ of the sort present in the starting complex (1.56 nm phase). The precession photographs show only Bragg reflections, even those with $k \neq 3n$. Figure 9 is a schematic drawing of the evolution of the structural changes which occur in the benzylammonium-vermiculite as it is heated.

REFERENCES

- Bailey SW. 1985. Classification and structures of micas. In: Bailey SW, editor. *Micas*. Rev Mineral 13, Washington, D.C.:Mineral Soc Am. 1–13.
- Brindley GW, Gillery FM. 1956. X-Ray identification of chlorite species. *Am Mineral* 41:169–181.
- de la Calle C, Suquet H. 1988. Vermiculite. In: Bailey SW, editor. *Hydrous Phyllosilicates*. Rev Mineral Vol 19, Washington, D.C.:Mineral Soc Am. 455–496.
- de la Calle C, Suquet H, Pons CH. 1988. Stacking order in a 14.30 Å Mg-vermiculite. *Clays & Clay Miner* 36:481–490.
- de la Calle C, Martin de Vidales JL, Pons CH. 1993. Stacking order in a K/Mg interstratified vermiculite from Malawi. *Clays & Clay Miner* 41:580–589.
- Cotton FA, Wilkinson G. 1988. *Advanced in Inorganic Chemistry*, 5th ed. New York:Wiley Interscience. 1455p.
- Fornes V, Rausell-Colom JA, Serratos JM, Hidalgo A. 1974. Estudio por espectroscopia infrarroja de los complejos vermiculite-ornitina. *Opt Aplic* 7:83–88.
- George WO, McIntyre PS. 1987. *Infrared Spectroscopy*. Chichester (U.K.):Wiley and Sons. 537p.
- Gonzalez Garcia F, Garcia Ramos G. 1960. On the genesis and transformation of the vermiculite. In: *Trans. 7th Int'l Congress Soil Science*. Madison: Int'l Society Soil Science 4:482–491.
- Guinier A. 1964. *Théorie et technique de la radiocristallographie*. Paris: Dunod. 490–663.
- Martin de Vidales JL, Vila E, Ruiz-Amil A, de la Calle C, Pons CH. 1990. Interstratification in Malawi vermiculite: Effect of bi-ionic K-Mg solutions. *Clays & Clay Miner* 38: 513–521.
- Mering J. 1949. L'interférence des rayons X dans les systèmes à stratification désordonnée. *Acta Cryst* 2:371–380.
- Mifsud A, Fornes V, Rausell-Colom JA. 1971. Cationic complexes of vermiculite with l-ornithine. *Proc. Reunion Hispano-Belga de Minerales de la Arcilla*, 121–127.
- Nakamoto K. 1986. *Infrared and Raman Spectra of Inorganic and Coordination Compounds*. New York: Wiley. 484p.
- Noel PG, Roeges. 1994. *A guide to the complete interpretation of Infrared Spectra of organic structures*. Chichester (U.K.):Wiley and Sons. 340p.
- Rausell-Colom JA, Fornes V. 1974. Monodimensional Fourier analysis of some vermiculite-l-ornithine complexes. *Am Mineral* 59:790–798.
- Slade PG, Telleria MI, Radoslovich EW. 1976. The structures of ornithine-vermiculite and 6-aminohexanoic acid-vermiculite. *Clays & Clay Miner* 24:134–141.
- Slade PG, Raupach M, Emerson WW. 1978. The ordering of cetylpyridinium bromide on vermiculite. *Clays & Clay Miner* 26:125–134.
- Slade PG, Raupach M. 1982. Structural model for benzidine-vermiculite. *Clays & Clay Miner* 30:297–305.
- Slade PG, Stone PA. 1983. Structure of a vermiculite-aniline intercalate. *Clays & Clay Miner* 31:200–206.
- Slade PG, Stone PA. 1984. Three-dimensional order and the structure of aniline-vermiculite. *Clays & Clay Miner* 32: 223–226.
- Slade PG, Dean C, Schultz PK, Self PG. 1987. Crystal structure of a vermiculite-anilinium intercalate. *Clays & Clay Miner* 35:177–188.
- Yamamuchi H, Kondo S. 1988. The structure of water and methanol adsorbed on silica gel by FT-NIR spectroscopy. *Colloid Polym Sci* 266:855–861.

(Received 2 November 1993; accepted 23 May 1995; Ms. 2433)