

MONTHLY 10/-

The Journal of
**THE ROYAL
AERONAUTICAL
SOCIETY**



CONTENTS

AUGUST 1951

PLANNING AND PRODUCTION METHODS USED IN
THE CONSTRUCTION OF THE DE HAVILLAND
COMET

H. POVEY, A.F.R.Ae.S.

REVIEWS

CORRESPONDENCE

●
LONDON

ROYAL AERONAUTICAL SOCIETY, 4 HAMILTON PLACE, W.1

Fully
Patented

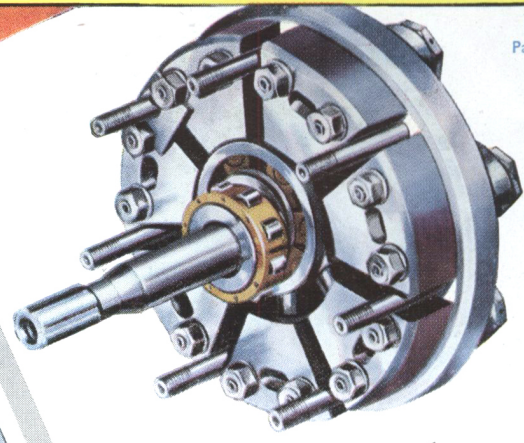

THE LOCKHEED MARK 7 HYDRAULIC PUMP

Outstanding in performance and
reputation. For pressures up to 3,000
P.s.i. at 4,000 r.p.m.
Weight only 7 lb. 6 oz.

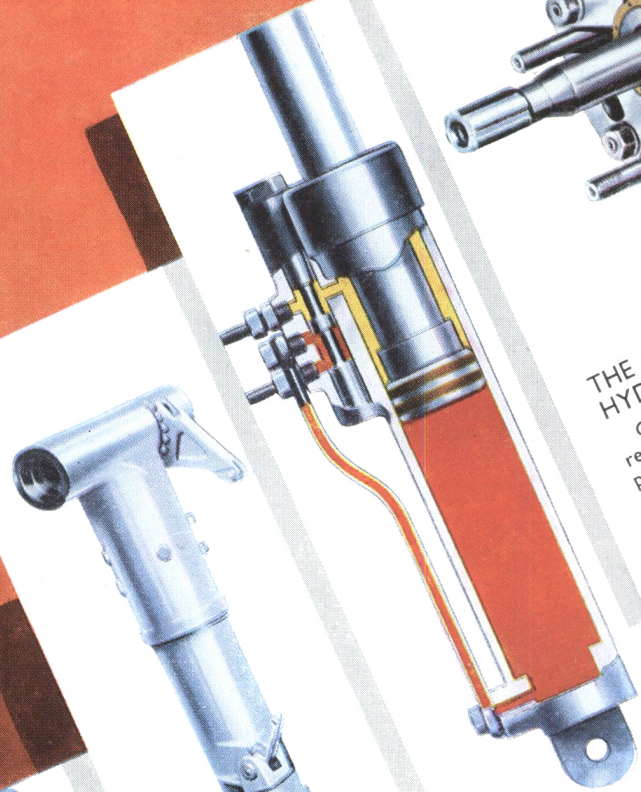

THE SERVODYNE*

The perfect system of power
assistance for flying controls.
Basic principle minimises 'dead
points.'

* Regd. Trade Mark



CANTILEVER STRUTS

used on many famous aircraft.

LOCKHEED HYDRAULIC JACKS

As made for numerous applications
ranging from a few hundred lb.
thrust to 55,000 lb.

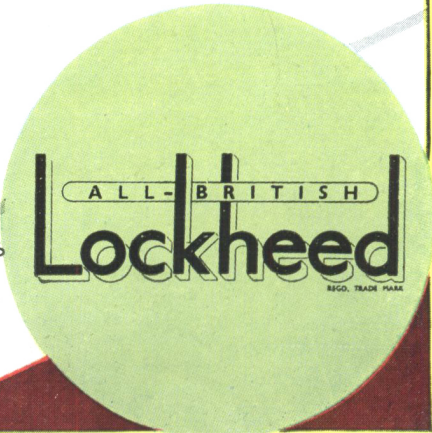

AUTOMOTIVE PRODUCTS COMPANY LTD., LEAMINGTON SPA

Ecuador Airlift -

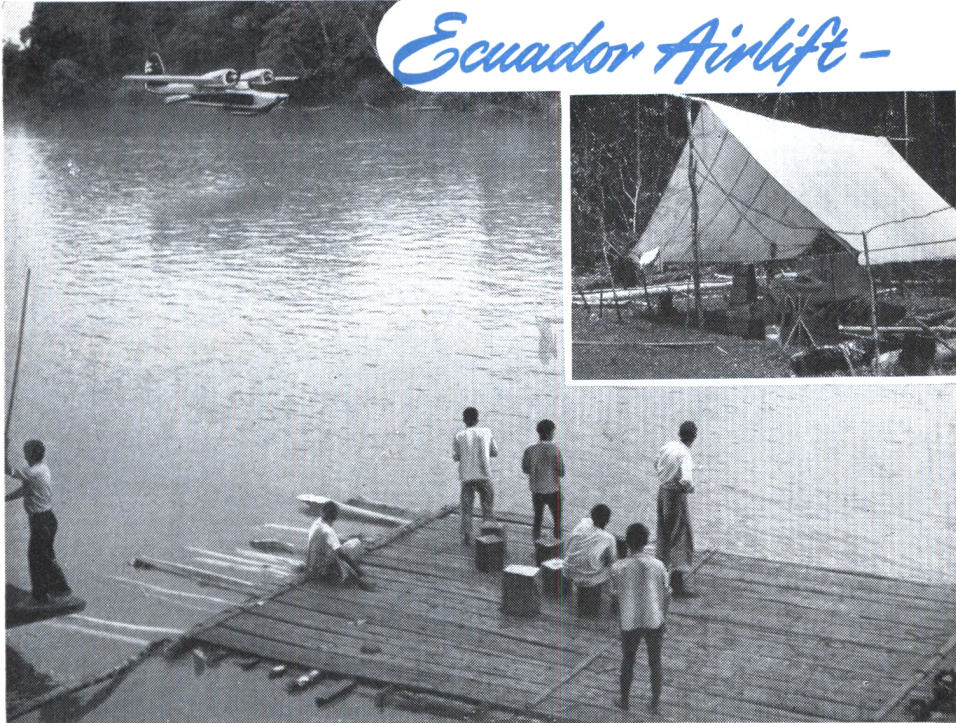

(Above) A Grumman amphibian aircraft lands on the Aguarico river near a survey camp in the Oriente region of Ecuador.

(Inset) A typical scene in a survey camp in the Oriente region of Ecuador.

Oil is found in awkward places. Much of it would stay there without the help of air transport which builds up the necessary airlift for survey and eventual drilling operations on inaccessible jungle and mountain sites. Airwork Limited play a leading part in the provision of these vital air services. Men, machinery and supplies are

dropped by parachute, are landed on improvised airstrips, or on nearby lakes and rivers. In their 22 years of aviation experience, Airwork have been early on the scene of most important developments in the use of air transport. Generally speaking, if a job is better done by air, it's better done by Airwork.



THE SERVICES OF AIRWORK

- Air Transport Contracting • Servicing and Maintenance of Aircraft • Overhaul and Modification of Aircraft • Sale and Purchase of Aircraft • Operation and Management of Flying Schools and Clubs • Radio Sales and Service • Insurance

AIRWORK LIMITED · 15 CHESTERFIELD STREET · LONDON · W.1 · TEL: GROSVENOR 4841

Also at: Blackbushe Airport, Nr. Camberley, Surrey. Booker Aerodrome, Marlow, Bucks. Gatwick Airport, Horley, Surrey. Langley Aerodrome, Bucks. Loughboro' Aerodrome, Dishley, Leics. Perth Aerodrome, Perthshire. R.A.F. Station, Digby, Lincs. Royal Naval Air Station, Brawdy, Nr. Haverfordwest, Wales. Usworth Aerodrome, Castletown, Co. Durham.

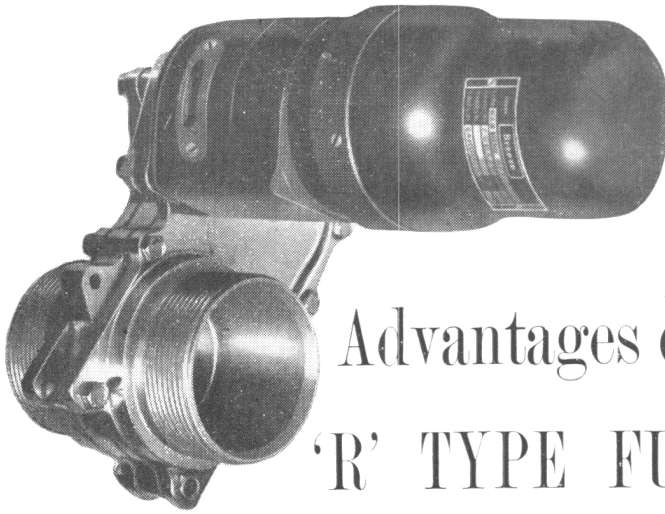

Advantages of the new 'R' TYPE FUEL COCK

The new 'R' type Fuel Cock is a most practical proposition. Operation is simple: a rotary arm link is attached to a carrier containing two stainless steel valve plates which have a sliding action over the 'Duralumin' valve seats.

Among the many advantages of the 'R' Cock are light weight and the low operating torque required at the various pressures and temperatures covered by R.A.E. Specifications AD.102 and AD.152. Installation in the fuel system is easy and maintenance simple. For example, the actuator may be removed without detaching the cock from the pipeline. Three mounting lugs are provided to aid installation.

Sizes available: 1", 1¼", 1½", 1¾", 2" B.S.P.

Metric and American threads are available.

VICKERS-ARMSTRONGS LIMITED

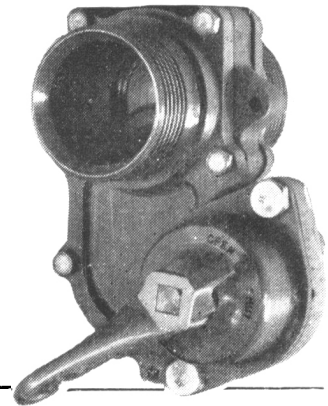

A1 127

VICKERS-ARMSTRONGS LIMITED · AIRCRAFT DIVISION · WEYBRIDGE · SURREY

Filling in the *Outlines*...



ONE SHILLING
WEEKLY
ANNUAL RATE
£3 · 3 · 0
POST FREE

... and placing in true perspective the significance of current aeronautical developments, THE AEROPLANE provides a weekly source of reliable information and sound comment on World Aviation.

TEMPLE PRESS LIMITED

BOWLING GREEN LANE, LONDON, E.C.1, TERMINUS 3636



THE MOTOR
THE AEROPLANE
LIGHT METALS

THE COMMERCIAL MOTOR
THE MOTOR SHIP
FARM MECHANIZATION

CYCLING
THE LIGHT CAR
MOTOR CYCLING

PLASTICS

THE OVERSEAS ENGINEER
THE MOTOR BOAT AND YACHTING
THE OIL ENGINE AND GAS TURBINE

B·O·A·C TAKES GOOD CARE OF YOU

TO ALL SIX CONTINENTS

*Consult your Travel Agent or
B.O.A.C: Airways Terminal,
Victoria, S.W.1 (VICToria 2323) or
Regent St., W.1 (MAYfair 6611)*

GREAT BRITAIN • USA • SPAIN
PORTUGAL • ITALY • SWITZERLAND
BERMUDA • NASSAU • CANADA
WEST INDIES • SOUTH AMERICA
MIDDLE EAST • WEST AFRICA • EAST
AFRICA • SOUTH AFRICA • PAKISTAN
INDIA • CEYLON • AUSTRALIA • NEW
ZEALAND • FAR EAST • JAPAN

FLY BRITISH BY **B·O·A·C**



BRITISH OVERSEAS AIRWAYS CORPORATION IN ASSOCIATION WITH QANTAS EMPIRE
AIRWAYS LIMITED, SOUTH AFRICAN AIRWAYS AND TASMAN EMPIRE AIRWAYS LIMITED



NAPIER

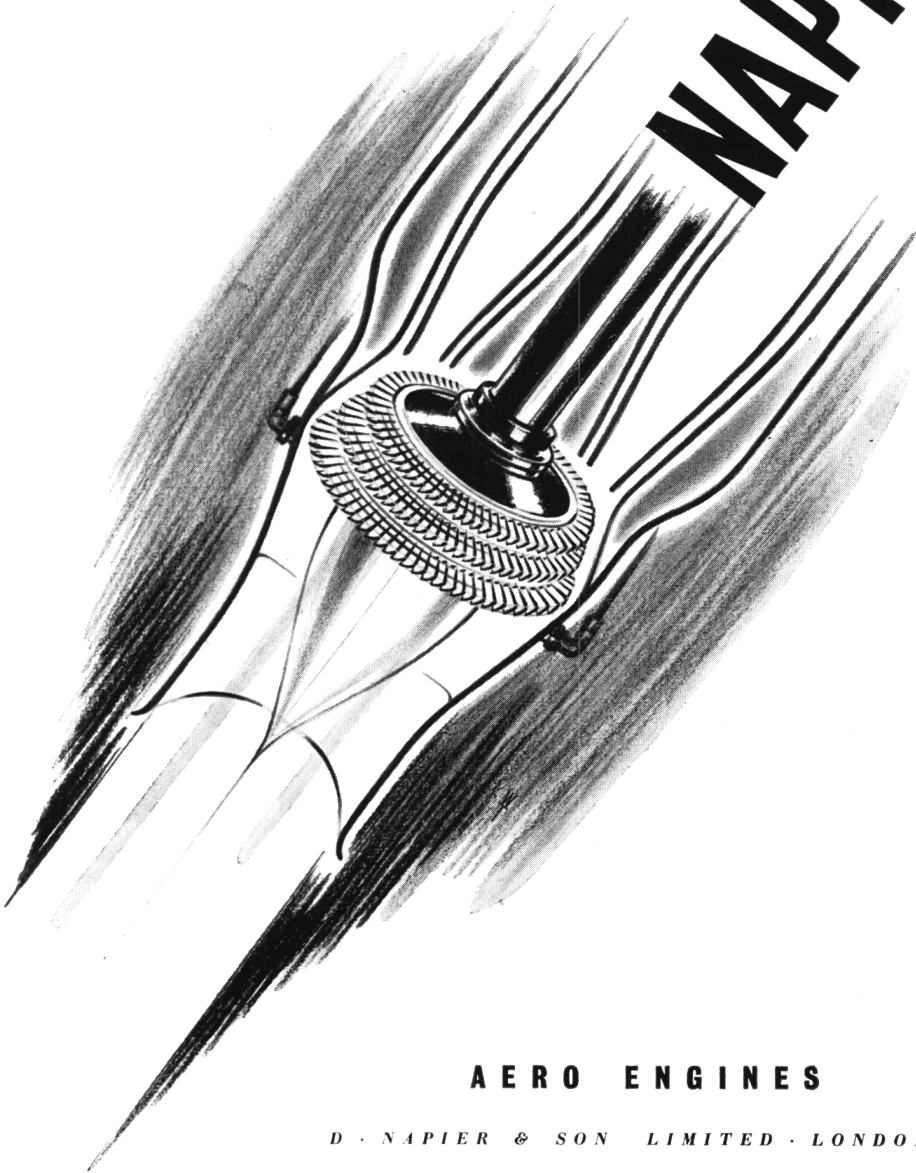

AERO ENGINES

D · NAPIER & SON LIMITED · LONDON · W3

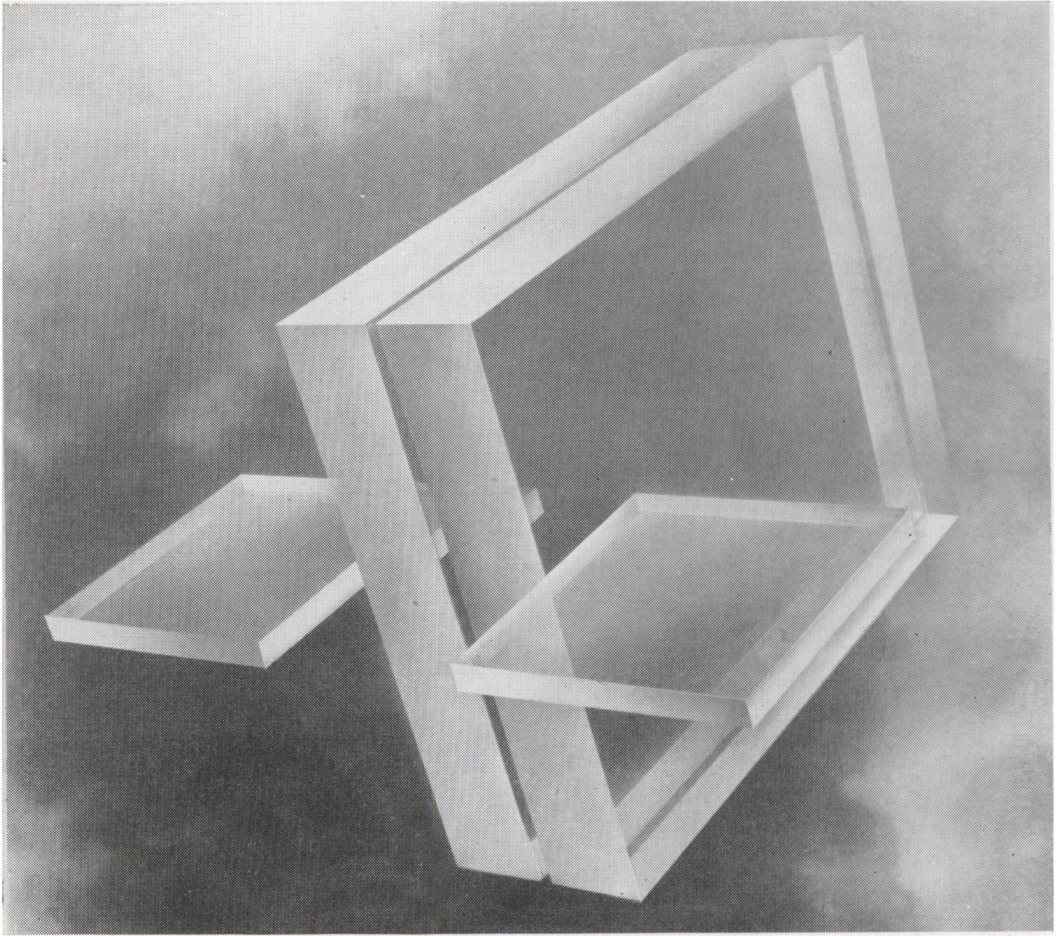

‘PERSPEX’ flies high

‘Perspex’ acrylic sheet meets the exacting requirements of the aircraft industry



‘Perspex’ is the registered trade mark of the acrylic sheet manufactured by I.C.I.

IMPERIAL CHEMICAL INDUSTRIES LTD LONDON SW1

P.472

Linking England with sixteen Countries . . .

AUSTRALIA'S INTERNATIONAL AIRLINE

In meeting today's requirements of trade and travel by air to the East, Australia, and the Pacific, Qantas provides a valuable international service—qualified by the experience of 30 years. Services covering over 30,000 miles of unduplicated air routes include—London-Sydney via Rome, Cairo, Karachi, Calcutta (alternatively via Bombay and Colombo), Singapore, Darwin, Sydney—in parallel with B.O.A.C.

Sydney-Hong Kong, via Labuan (North Borneo) · Sydney-Tokyo, via Manila · Sydney-New Guinea, New Britain and Solomon Islands, via North Queensland airports · Sydney-Pacific Islands, including Norfolk Island, Noumea and Suva · Sydney-Auckland and Sydney-Wellington (by TEAL) linking with the London-Sydney Service. Full details from travel agents.

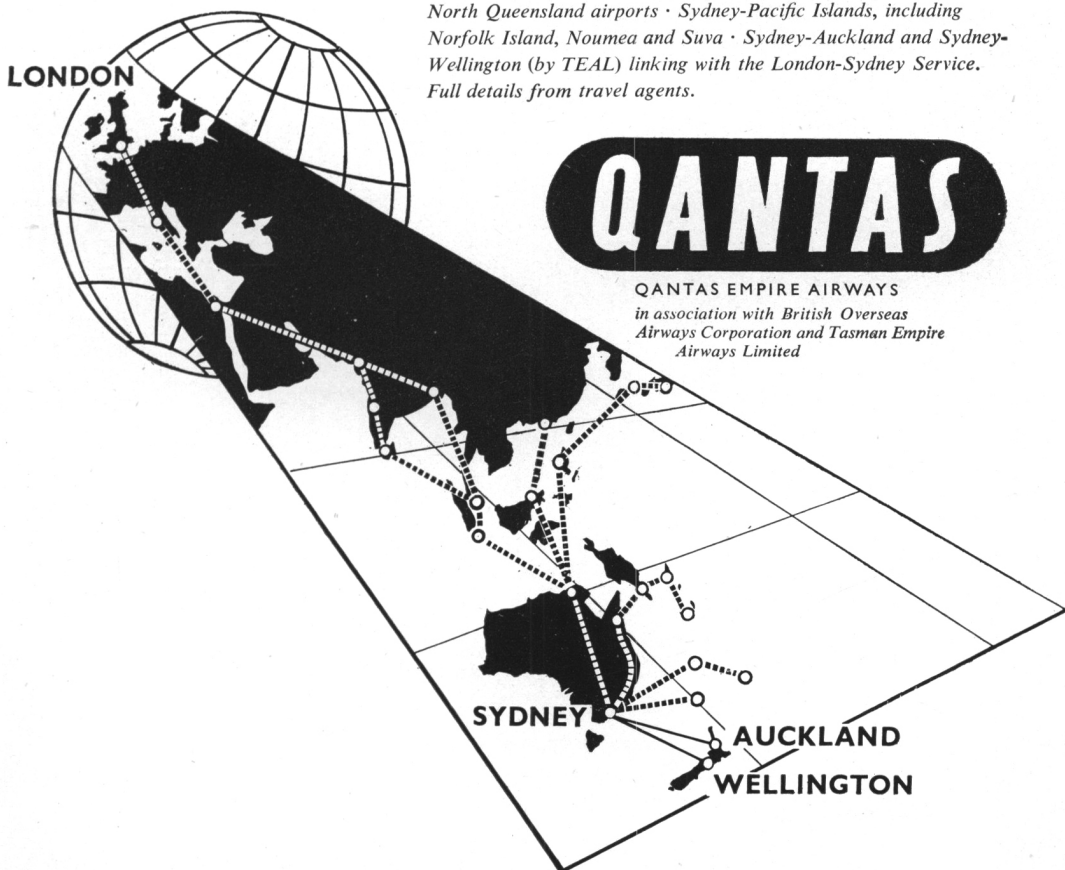

HAWKER SIDDELEY

*Within the framework of
this great organisation each
individual company operates
as a completely separate entity,
controlling its own affairs en-
tirely—but by pooling its experi-
ence and resources, each company
has behind it the combined strength
of the Group—unmatched facilities
for design, research and production.*

Group

LEADERS OF AN INDUSTRY



ARMSTRONG SIDDELEY MOTORS LTD
SIR W. G. ARMSTRONG WHITWORTH AIRCRAFT LTD
GLOSTER AIRCRAFT CO. LTD · A. W. HAWKSLEY LTD
HAWKER AIRCRAFT LTD · HIGH DUTY ALLOYS LTD
A. V. ROE & CO. LTD · A. V. ROE CANADA LTD
AIR SERVICE TRAINING LTD

The Hawker Siddeley Group Ltd. 18 St. James's Square, S.W.1. Telephone: Whitehall 2064.

Consult the G.E.C. on

COMPLETE AIRPORT ELECTRIFICATION

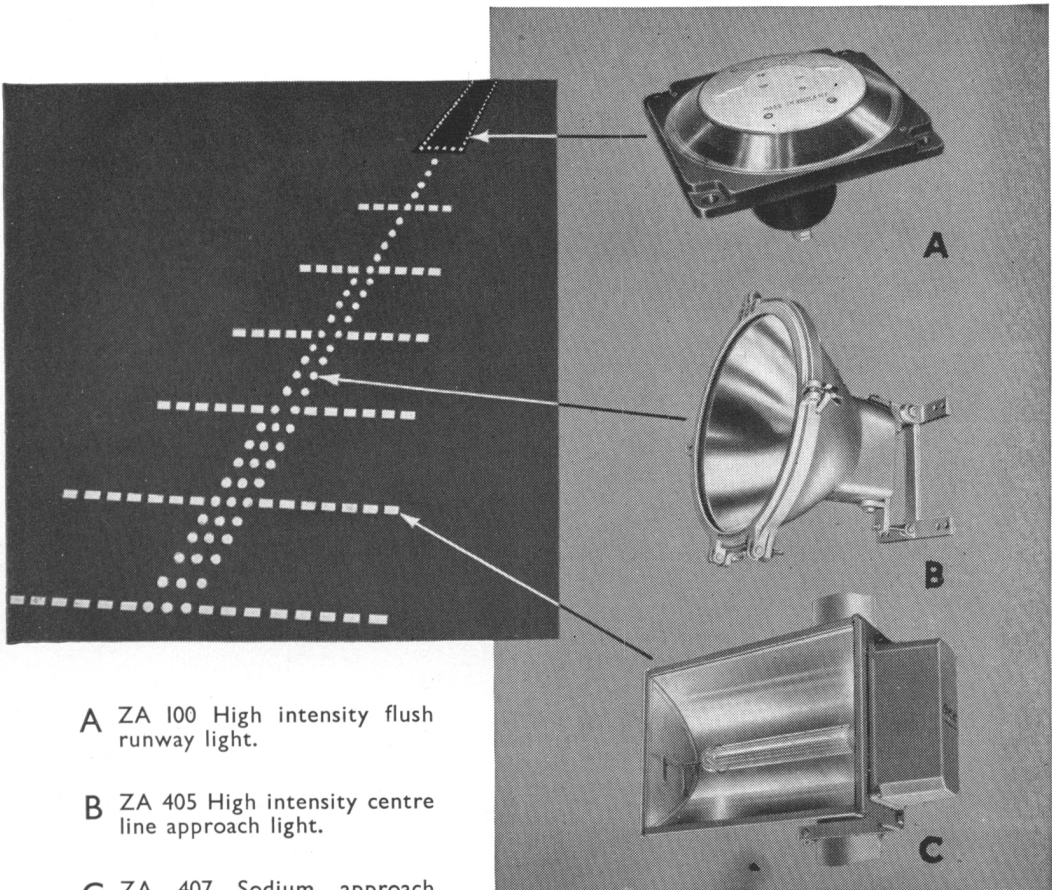

A ZA 100 High intensity flush runway light.

B ZA 405 High intensity centre line approach light.

C ZA 407 Sodium approach light.

Three examples of G.E.C. Airport Lighting equipment designed for use in bad visibility; the diagram showing how they are incorporated in a "Line and Bar approach" landing system.

THE GENERAL ELECTRIC CO. LTD., MAGNET HOUSE, KINGSWAY, LONDON W.C.2

WESTON

AIRCRAFT INSTRUMENTS

No. 1. Temperature Measuring

The comprehensive range of Weston temperature measuring instruments covers the requirements of existing production aircraft, as well as types now under development. In addition to thermometry for the indication of cylinder, air, oil and radiator temperatures, Weston equipment for aircraft includes instruments for supply, navigational aid instruments, selector switches, etc.

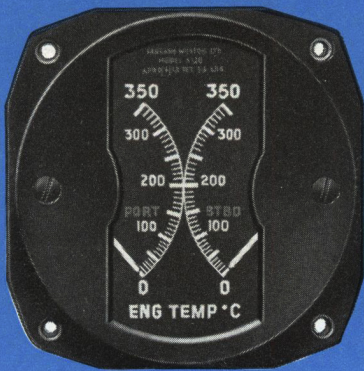

Model S. 128. Dual Engine Temperature Indicator, comprising two Millivoltmeters of 100° scale housed in large-size S.A.E. case. For use in conjunction with copper/constantan, iron/constantan, or chrome/alumel thermocouples.

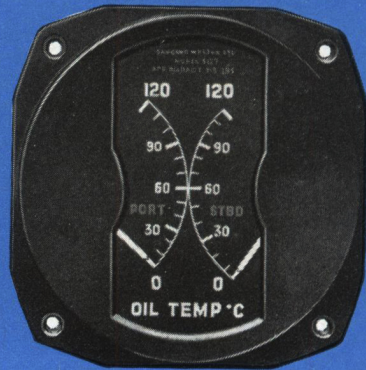

Model S. 127. Dual Ratiometer Indicator, comprising two 100° ratiometer movements housed in large-size S.A.E. case. For use in conjunction with thermometer bulbs, electrical oil pressure transmitters, electrical position indicators or any combination of two of these to indicate a variety of temperatures, pressures or positions.

SANGAMO WESTON LIMITED • Enfield • Middlesex
Tel.: Enfield 3434 (6 lines) and 1242 (4 lines). Grams: Sanwest, Enfield
Scottish Factory: Port Glasgow • Renfrewshire • Scotland

Branches:
 Glasgow, Manchester, Newcastle-on-Tyne, Leeds, Wolverhampton, Bristol, Southampton, Brighton, Liverpool, Nottingham.

**UNDERCARRIAGES
BY
ELECTRO -
HYDRAULICS LTD**

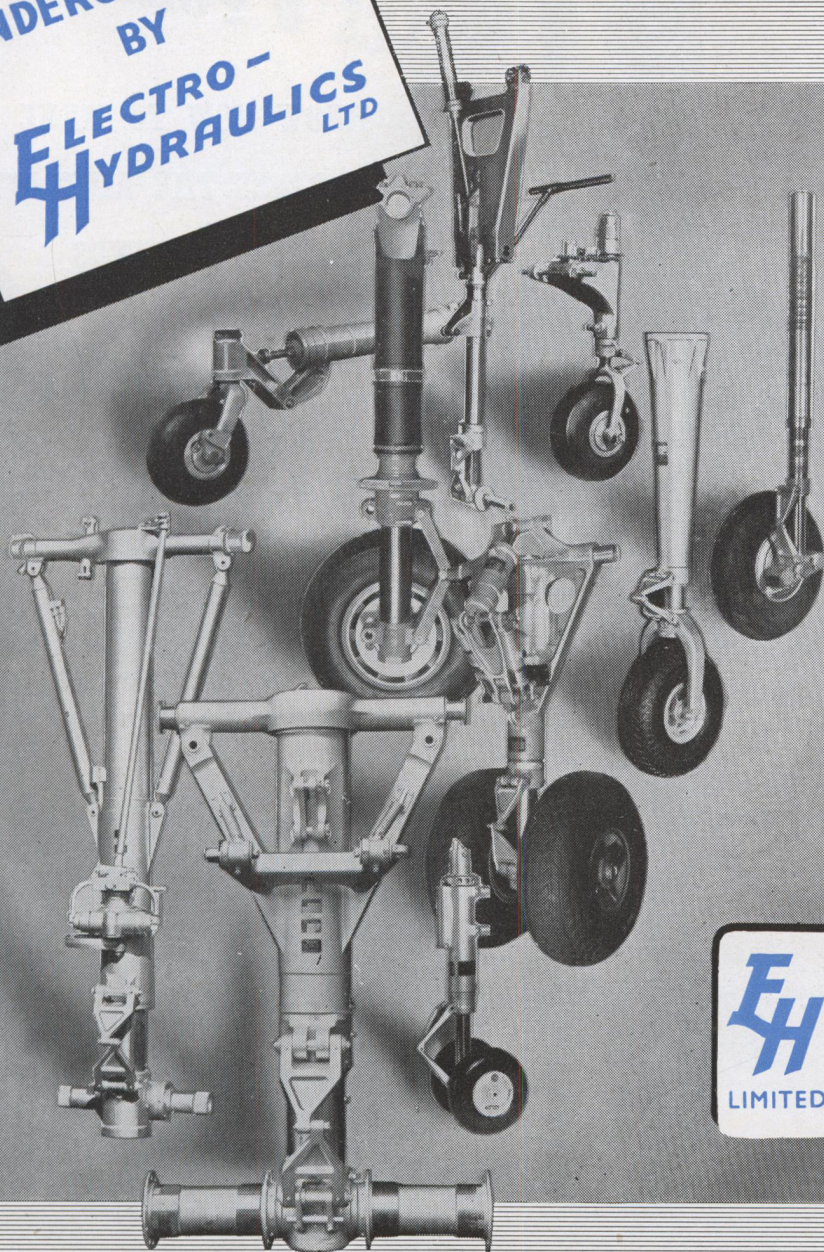

**SPECIALIST DESIGNERS & CONSTRUCTORS OF
UNDERCARRIAGES HYDRAULIC & PNEUMATIC EQUIPMENT
LIVERPOOL ROAD, WARRINGTON Tel: 2244**

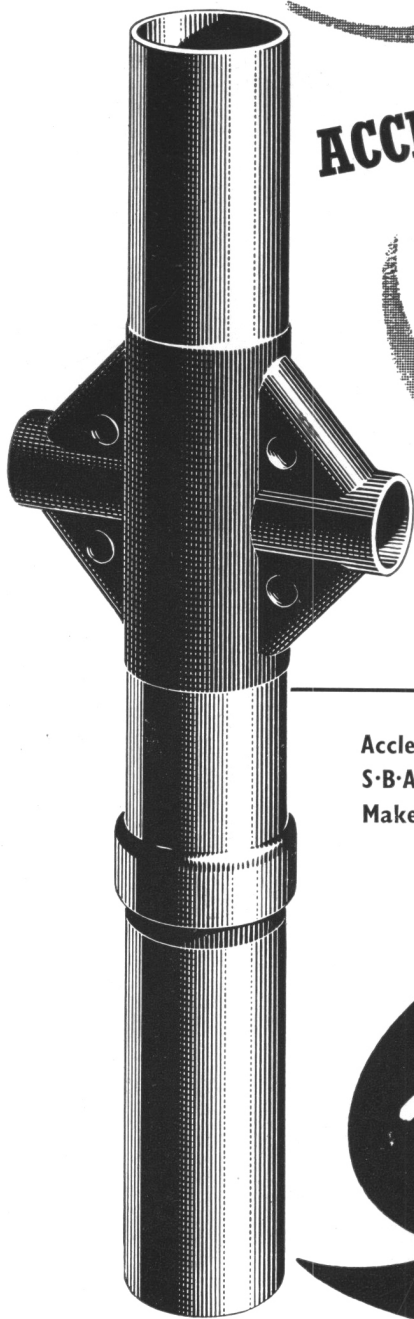

ACCLES & POLLOCK

**KNOW HOW TO MAKE
THE TUBES THE AIRCRAFT
INDUSTRY NEEDS**

TOP FITTING

by courtesy of

Dowty Equipment Ltd.

Accles & Pollock are exhibiting at the
S·B·A·C EXHIBITION · FARNBOROUGH · SEPT 11-16
Make an opportunity of seeing STAND No 63

Precisely!

ACCLES & POLLOCK LTD · OLDBURY · BIRMINGHAM

MAKERS AND MANIPULATORS OF SEAMLESS TUBES, IN STAINLESS AND OTHER STEELS

A



COMPANY
124/126

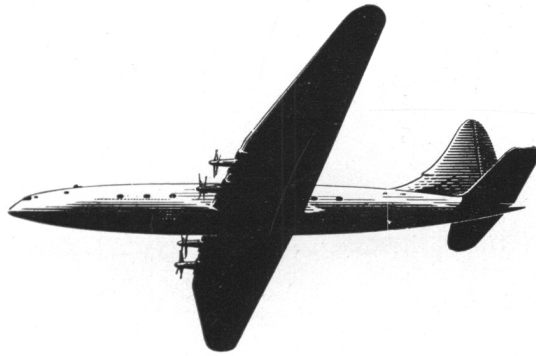

Bristol sleeve-valve engines in service

Nearly thirty years ago the prototype of the famous "Bristol" Jupiter delivered about 350 B.H.P. Today, the mighty Centaurus sleeve-valve engine gives nearly 3,000 B.H.P., a story of achievement in technical evolution, quality of manufacture, and world wide service. "Bristol" pioneered the sleeve-valve aero engine, and today the Hercules and Centaurus types are chosen by leading aircraft constructors at home and overseas for their high performance, great reliability, economy and ease of maintenance.



BRISTOL FREIGHTER

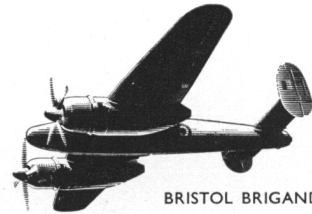

BRISTOL BRIGAND



AIRSPEED AMBASSADOR



HANDLEY-PAGE HERMES IV

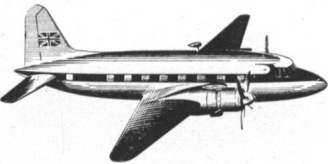

VICKERS VIKING

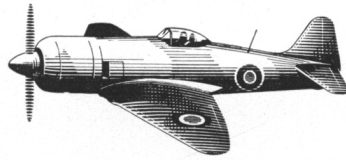

HAWKER SEA FURY

THE BRISTOL AEROPLANE COMPANY LIMITED · ENGLAND



PULLIN

*Turn
and Slip
Indicators*

ARE FITTED TO

DE HAVILLAND COMET · SUPERMARINE ATTACKER

APOLLO · BLACKBURN YA 5 · ENGLISH ELECTRIC CANBERRA

GLOUCESTER METEOR 8 AND NF 11

DE HAVILLAND VENOM AND MANY OTHERS

R . B . P U L L I N & C O L T D

Suppliers of Instruments for Service and Civil Aircraft

PHOENIX WORKS, GREAT WEST ROAD, BRENTFORD, MIDDLESEX

Telephone : EALing 0011/3 & 3661/3

Telegrams : Pullinc, Wesphone, London.

18454



Electric Equipment for Aircraft

With unrivalled manufacturing resources, backed by continual research and development and fifty-three years' experience. BTH enjoys an enviable reputation for the quality of its products. Reliability is of prime importance on land, but is vital in the air, hence the success of BTH aircraft magnetos, and electrical equipment including :

Motor-generating sets with electronic regulators · Gas-operated turbo-starters · Actuators · A.C. and D.C. Motors · Generators · Mazda lamps, etc.

BRITISH THOMSON-HOUSTON

THE BRITISH THOMSON-HOUSTON CO., LTD., COVENTRY, ENGLAND

A4039

DOWTY

Bonded Seals

5,000

on every

Comet

for

Integral Tank Sealing

*British Patents Nos.
537654 and 576233*

DOWTY SEALS LIMITED, CHELTENHAM

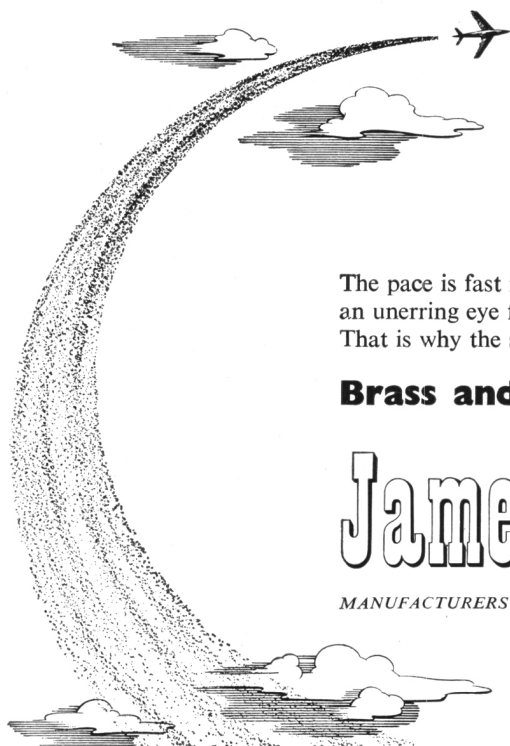

The pace is fast...

The pace is fast in the aircraft industry, and demands an unerring eye for the best in raw materials. That is why the specification so often includes James Booth's

Brass and Copper for Aircraft

James Booth

MANUFACTURERS OF THE FAMOUS "DURALUMIN" LIGHT ALLOYS

JAMES BOOTH & CO. LTD · ARGYLE STREET WORKS · BIRMINGHAM 7

CHAPMAN & HALL

MONOGRAPHS ON MATERIALS

Published under the authority of
THE ROYAL AERONAUTICAL SOCIETY

First titles

THE PROPERTIES OF METALLIC MATERIALS AT LOW TEMPERATURES

by P. LITHERLAND TEED, F.R.A.E.S.

Demy 8vo 232 pages 8 Figures 21s. net (Published 28th April 1950)

THE STRUCTURE AND MECHANICAL PROPERTIES OF METALS

by BRUCE CHALMERS, D.SC., F.INST.P.

Demy 8vo 132 pages 89 Figures 73s. net (Published 18th January 1951)

ADHESIVES FOR WOOD

by R. A. G. KNIGHT, B.SC., M.I.MECH.E.

Demy 8vo 256 pages 19 Figures 6 Plates 22s. 6d. net (In the Press)

Other Titles in Preparation

37 ESSEX STREET, LONDON, W.C.2

SELECTED FOR THE ROYAL AIR FORCE

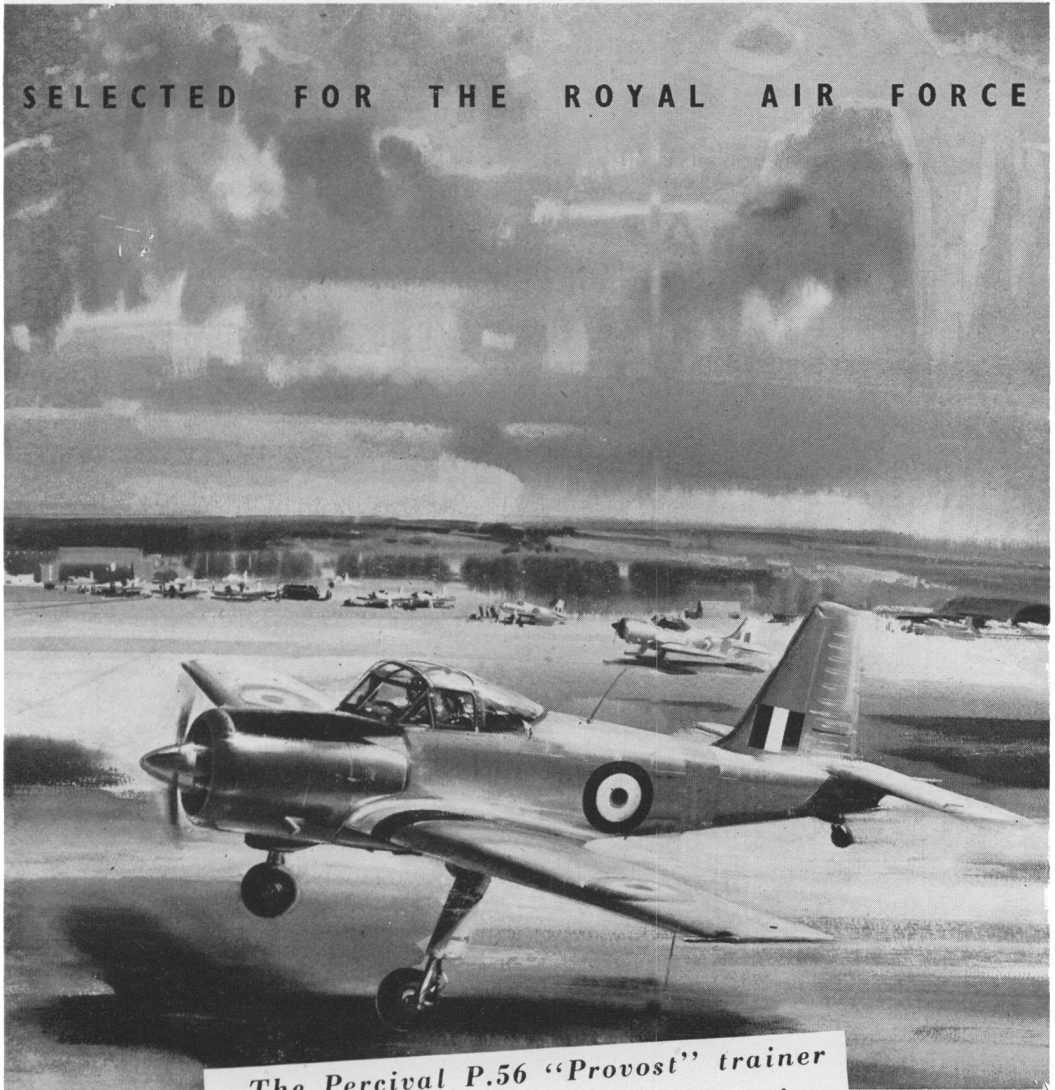

*The Percival P.56 "Provost" trainer
with the Alvis Leonides Engine*



LEONIDES

ALVIS LIMITED, COVENTRY, ENGLAND

ON THE DE HAVILLAND COMET...

6 *Successive starts
on one battery
charge*

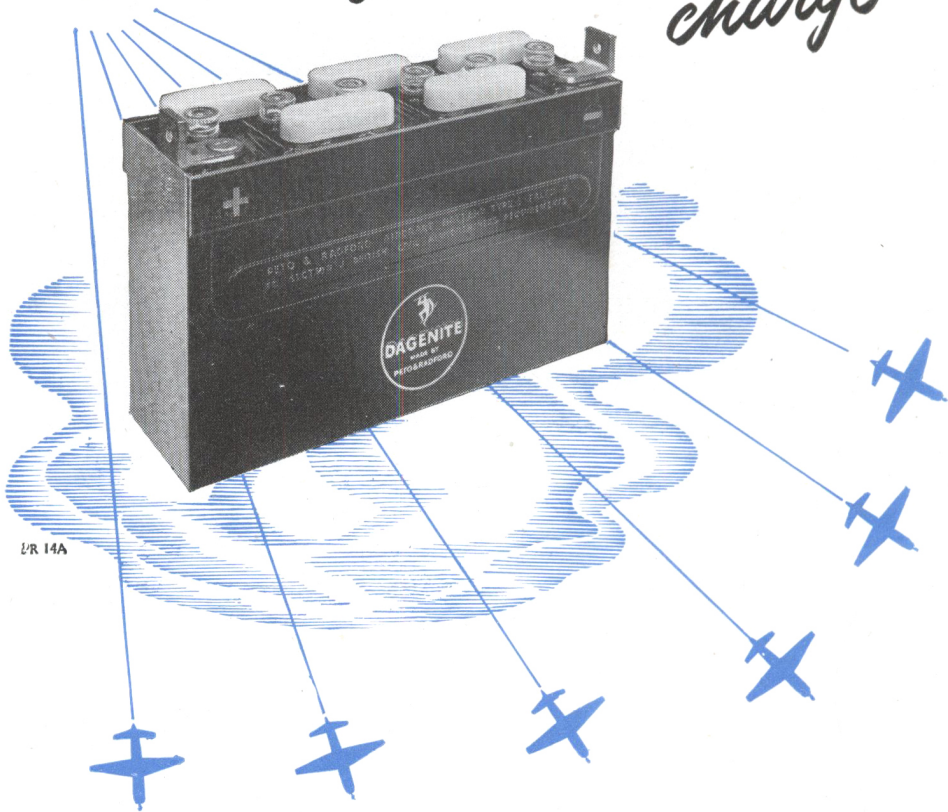

LR 14A

Although ground starting of the jet engines is the normal procedure, these batteries have been specially designed to start the Comet from inside the aircraft when required. On test recently a fully-charged 24-volt set of batteries gave six successive starts without any charge during the intervening 5-minute rest periods. An exceptional performance for a 60 ampere-hour battery weighing only 52½ lb.

DAGENITE AIRCRAFT BATTERIES

P E T O A N D R A D F O R D 5 0 G R O S V E N O R G A R D E N S · L O N D O N · S W I

XX

OFFICIALS OF THE BRANCHES OF THE SOCIETY IN THE UNITED KINGDOM

BELFAST

President: G. T. R. HILL, Esq., M.C., F.R.Ae.S.
Chairman: Rear Admiral M. S. SLATTERY, C.B.,
 F.R.Ae.S., R.N. (Retd.).
Hon. Secretary: J. A. KIRK, Esq., A.F.R.Ae.S.,
 Short Brothers & Harland Ltd.,
 Queen's Island, Belfast, N.I.

BIRMINGHAM

President: S. C. REDSHAW, Esq., F.R.Ae.S.
Secretary: C. P. HOMES, Esq., A.R.Ae.S.,
 81 Peplins Way,
 Kings Norton, Birmingham, 30.

BRISTOL

President: Air Chief Marshal Sir ARTHUR
 BARRATT, C.M.G., M.C.
Chairman: F. H. POLLICUTT, Esq., F.R.Ae.S.
Hon. Secretary: J. M. HAHN, Esq., Grad.R.Ae.S.,
 Structures Dept., Aircraft Division,
 Bristol Aeroplane Co. Ltd., Filton, Bristol.

BROUGH

President: R. BLACKBURN, Esq., F.R.Ae.S.
Chairman: G. E. PETTY, Esq., F.R.Ae.S.
Secretary: F. A. WILKINSON, Esq., A.F.R.Ae.S.,
 Design Office,
 Blackburn & General Aircraft Ltd.,
 Brough, E. Yorks.

COVENTRY

President: H. M. WOODHAMS, Esq., C.B.E..
Chairman: W. J. PETERS, Esq., [F.R.Ae.S.
Secretary: C. T. SCULTHORPE, Esq., A.F.R.Ae.S.,
 Design Dept.,
 Sir W. G. Armstrong Whitworth Aircraft
 Baginton, Coventry. [Ltd.]

DERBY

President: LORD HIVES, M.B.E., F.R.Ae.S.
Chairman: A. G. ELLIOTT, Esq., C.B.E.,
 F.R.Ae.S.
Secretary: C. AINSWORTH DAVIS, Esq.,
 Rolls-Royce Ltd., Derby. [A.F.R.Ae.S]

GLASGOW

Chairman: T. B. LYON, Esq., A.F.R.Ae.S.
Secretary: R. C. HUNTER, A.R.Ae.S.,
 4 Lyle Place,
 Hunterhill, Paisley.

GLOUCESTER AND CHELTENHAM

President: G. H. DOWTY, Esq., F.R.Ae.S.
Chairman: R. W. WALKER, Esq., F.R.Ae.S.
Secretary: C. E. HUTT, Esq.,
 c/o S. Smith & Sons Ltd.,
 Bishops Cleeve, Cheltenham.

HALTON

President: Marshal of the Royal Air Force
 VISCOUNT TRENCHARD, Hon.F.R.Ae.S.
Chairman: Wing Commander L. A. W.
 DEANE, A.R.Ae.S.
Secretary: J. N. ANGLESS, A.R.Ae.S.,
 Station Headquarters, Royal Air Force,
 Halton, Aylesbury, Bucks.

HATFIELD

President: Sir GEOFFREY DE HAVILLAND, C.B.E.,
 A.F.C., R.D.I., Hon.F.I.Ae.S., F.R.Ae.S.
Chairman: J. E. WALKER, Esq., A.F.R.Ae.S.
Secretary: E. J. MANN, Esq., A.R.Ae.S.,
 de Havilland Aircraft Co. Ltd.,
 Hatfield, Herts.

ISLE OF WIGHT

President: Sir ARTHUR GOUGE, F.R.Ae.S.
Chairman: H. KNOWLER, Esq., F.R.Ae.S.
Secretary: P. H. CURNOW, Esq., Grad.R.Ae.S.,
 Design Office,
 Saunders-Roe Ltd., Osborne, I.o.W.

LEICESTER

Chairman: W/Cdr. H. E. FALKNER, A.F.R.Ae.S.
Hon. Secretary: F. WATKIN, Esq., A.F.R.Ae.S.
 Auster Aircraft Ltd., Rearsby, Leicester.

LUTON

Chairman: S. A. CLARKE, Esq., A.F.R.Ae.S.
Secretary: P. A. DRILLIEN, Esq., A.R.Ae.S.,
 c/o D. Napier & Son Ltd., Luton, Beds.

MANCHESTER

President: Sir ROY H. DOBSON, C.B.E., J.P.,
 F.R.Ae.S.
Chairman: C. E. FIELDING, Esq., A.F.R.Ae.S.
Secretary: J. A. E. WATERFALL, Esq.,
 56 Manor Avenue,
 Ashton-on-Mersey, Cheshire.

PORTSMOUTH

President: A. TOWNSLEY, Esq.
Chairman: G. H. M. TWYNAN, Esq.
Secretary: E. M. BELLAMY, Esq.,
 c/o Airspeed Ltd. The Airport,
 Portsmouth, Hants.

PRESTON

President: Sir GEORGE NELSON.
Secretary: D. B. SMITH, Esq., A.F.R.Ae.S.,
 Aircraft Division, English Electric Co. Ltd.,
 Warton Aerodrome, nr. Preston, Lancs.

READING

President: Sir FREDERICK HANDLEY PAGE,
 C.B.E., Hon.F.R.Ae.S.
Chairman: E. W. GRAY, Esq., A.F.R.Ae.S.
Secretary: E. L. PEARSON, Esq., A.R.Ae.S.,
 c/o Handley Page (Reading) Ltd.,
 The Aerodrome, Woodley, Reading, Berks.

SOUTHAMPTON

Chairman: Prof. F. I. RICHARDS, F.R.Ae.S.
Secretary: H. C. SMITH, Esq., A.F.R.Ae.S.,
 Vickers-Armstrongs Ltd.,
 Supermarine Works,
 Hursley Park, Winchester, Hants.

WEYBRIDGE

President: G. R. EDWARDS, Esq., F.R.Ae.S.
Chairman: H. H. GARDNER, Esq., F.R.Ae.S.
Secretary: J. H. SINCLAIR, Esq., A.R.Ae.S.,
 Vickers-Armstrongs Ltd., Weybridge, Surrey.

YEOVIL

Secretary: L. A. LANSDOWN, Esq., A.F.R.Ae.S.,
 Westland Aircraft Ltd., Yeovil, Somerset.

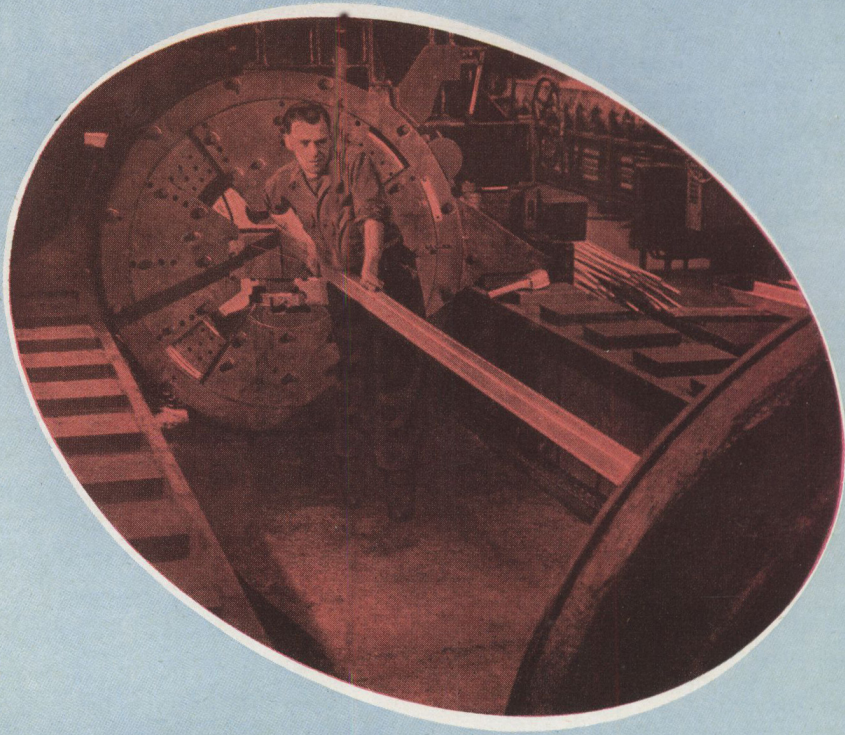

Extrusions in 'Hiduminium'

Because of its easy flow and the fact that it can be extruded with a minimum amount of wear on dies and tools 'Hiduminium' sections can be produced in an almost endless variety of shapes. Following the extrusion process, sections are straightened and checked for trueness in the 250 ton straightening machine shown above. 'Hiduminium' Extrusions enable many industries to

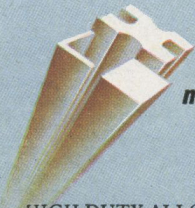

make light work of it with

**HIGH
DUTY
ALLOYS**

HIGH DUTY ALLOYS LTD., Slough, Bucks. Telephone : Slough 21201. Ingot, Billets, Forgings, Castings & Extrusions in 'Hiduminium'* and Magnuminium'* Aluminium & Magnesium Alloys.
*REGISTERED TRADE MARKS