

**IMPORTANT to Aeroplane Manufacturers.**

For . . .

**Tin Plating, Lead Plating, Nickel Plating,**

*Send to the actual Works, who Specialise in*

ALL KINDS OF

**PLATING, OXIDISING, BRONZING and GILDING.**

**JOHN WILKINS & Co.,**

**231 to 243, St. John Street, Clerkenwell, E.C.**

*Telephone Nos.:*

**HOLBORN 1675. CENTRAL 8611.**

*Telegrams:*

**"BRONZITE, LONDON."**

**Sheet Metal Workers, Stampers, Spinners, etc.**

ESTABLISHED LONDON AND PARIS, 1873.

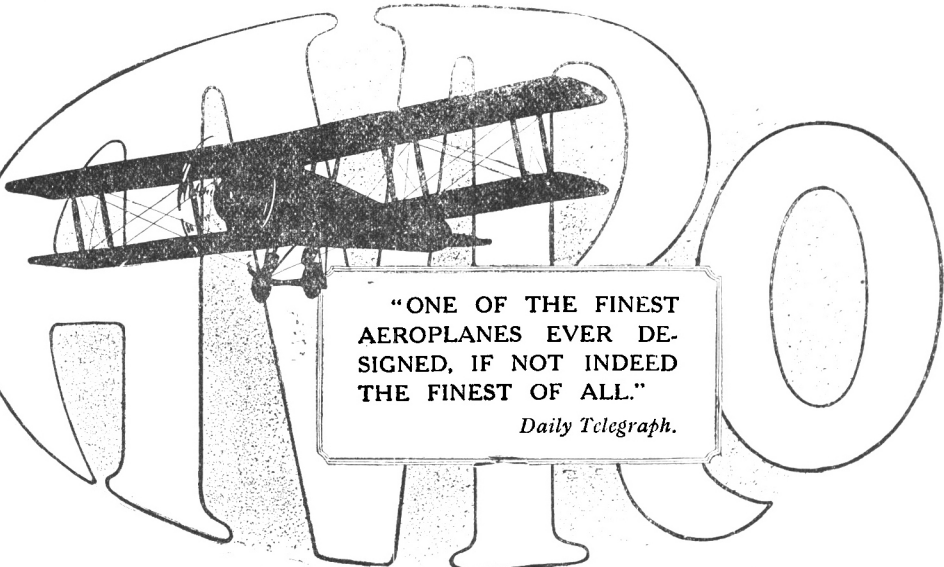

**"ONE OF THE FINEST  
AEROPLANES EVER DE-  
SIGNER, IF NOT INDEED  
THE FINEST OF ALL."**

*Daily Telegraph.*

**Aeroplanes and Parts**

**A. V. ROE & Co., Ltd., . . .** Designers and Constructors of  
Aeroplanes and Accessories.

**MANCHESTER.**

And 166, Piccadilly, London, W.

**SOUTHAMPTON.**

Telephone: **GERRARD 3186.**



The SIDDELEY-DEASY  
Motor-Car Co. Ltd. Coventry.  
*Contractors to H.M. Air Ministry:  
Designers & Constructors of Aero Engines,  
Aeroplanes & Luxurious Motor Carriages.*

Godbolds.

**ESTABLISHED 1912.**

**Contractors to H.M. Air Ministry.**

**THE**

**SUPERMARINE**

**AVIATION WORKS, Ltd.**

Designers and  
Constructors of

**FLYING BOATS**

Telephone :  
**WOOLSTON 37.**

Telegrams :  
**"SUPERMARIN."**



Offices, Works,  
Flying Waters,

**SOUTHAMPTON, ENG.**

H. SCOTT-PAINE, Director and General Manager.

TOLEDO BRAND



# AIRCRAFT STEELS.

All Grades : by Electric, Siemens, and Crucible Processes  
Heat-treated, Forged or Rolled,  
to Airboard & Engineering Standard Specifications.

**JNO. HY. ANDREW & Co., Ltd.,**  
Toledo Steel Works,

*London Offices—*

City : 118, Cannon St., E.C.4.

Westminster : 17, Victoria St., S.W.1.

**SHEFFIELD,**

**ENGLAND.**

*Telegraphic & Cable Address : "ANDREW, SHEFFIELD."*

TELEPHONE : GERRARD 7337.

TELEGRAMS : "GRATZELIM, OX LONDON."

# GRATZE, Ltd.,

44 to 46, Whitfield Street, LONDON, W.1.

*Manufacturing, Mechanical, General and  
Electrical Engineers and Contractors.*

Branch Works :

18, Tottenham Street, London, W.1.,

and 43, Beech Street,

Barbican, London, E.C.

Agents for Scotland :

CHISHOLM, MUIR & Co.,

108a, West Regent Street,

Glasgow.

**CONTRACTORS TO H.M. GOVERNMENT and DEPARTMENTS.**

War Office, Royal Aircraft Factory, Ministry of Munitions, Munitions Inventions Department  
The Air Board, Metropolitan Munitions Committee, etc.

For all classes of Machined Work, Repetition Work,  
Mechanical Apparatus, and Electrical Parts, etc.

**AIRCRAFT WORK.**—FITTINGS, COMPONENTS, ETC., PETROL COCKS, GAUGES, PUMPS  
FILTERS, UNIONS, ETC., OIL AND TANK FITTINGS AND CONNECTIONS, PRESSED WORK  
AND PARTS, OXY-ACETYLENE WELDING, SPINNING AND STAMPING.

MECHANICAL CORK PARTS AND CORK INSULATORS, DISCS AND PACKING FOR ALL PURPOSES.

We Specialise in the Manufacture

OF

# DROP FORGINGS

FOR ALL TRADES.

SEND YOUR ENQUIRIES

TO

**JOHN GARRINGTON & SONS, LTD.,**

ALBERT WORKS,

**DARLASTON, STAFFS.**

Telegrams : "Garringtons, Darlaston."

Telephone : 53 Darlaston.

**E. BENNETT & SON, L<sup>TD.</sup>**

EVERY APPLIANCE FOR

# HEATING

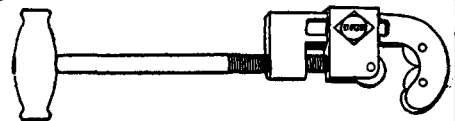
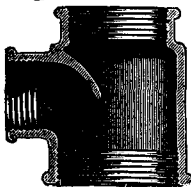

AEROPLANE HANGARS.  
AIRCRAFT FACTORIES, ETC.

'PHONE OR WRITE FOR CATALOGUES.

PHONE : 8062-4 AVENUE.  
SPRUCENESS.  
GRAMS : ALD. LONDON.

45/51, LEMAN STREET, E.1.



*Flying Boat - built two years before the war - about to ascend from the land*

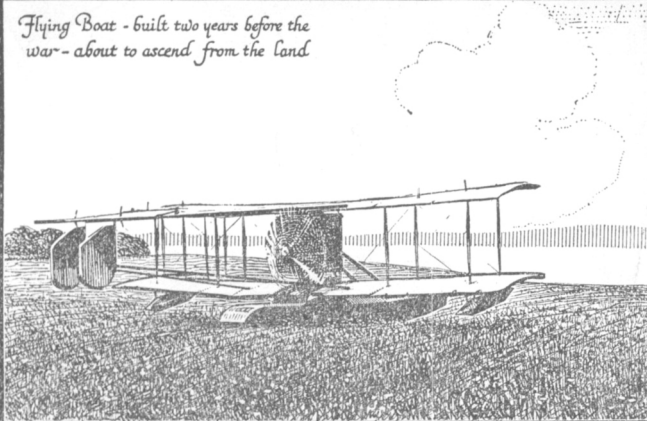

# SAUNDERS OF COWES in the Isle of Wight

*Designers & Constructors*



*of Air & Marine Craft*

*Telegrams: "Consuta" E. Cowes  
Phone: Cowes 193 (4 lines)*



S. E. Saunders Ltd.

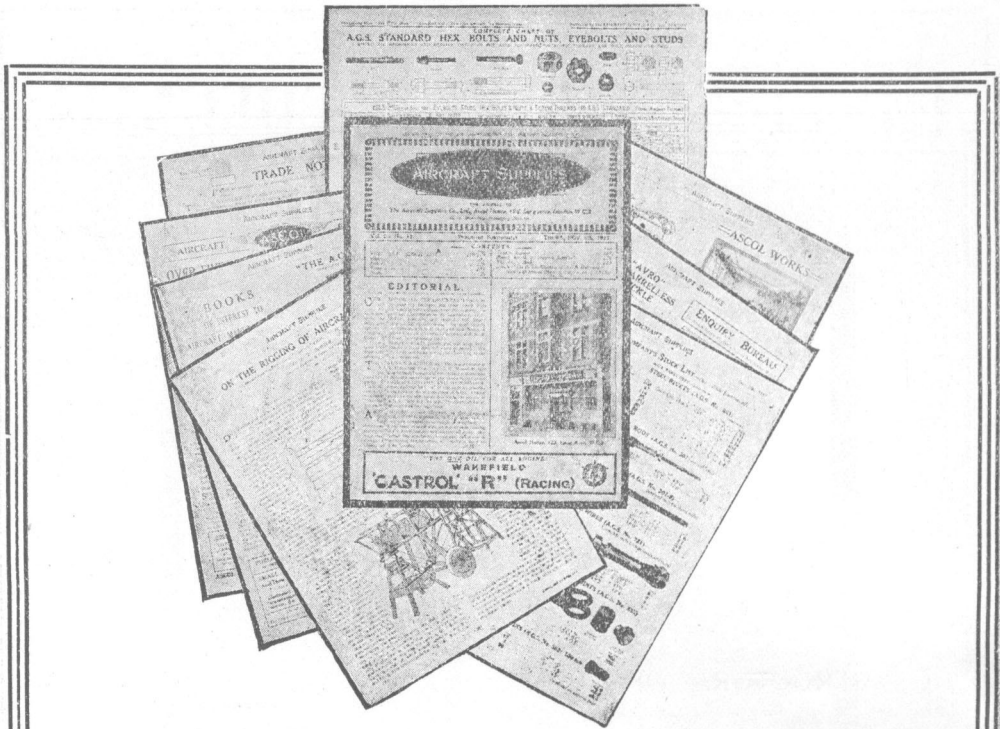

# ARE YOU A SUBSCRIBER

to "Aircraft Supplies," our fortnightly House Journal, which contains articles of interest to Aircraft Manufacturers, an Enquiry Bureau, Articles by the Sales Manager at "Ascol" House, and a complete list of stock, with current prices, up to the time of going to press ?

**If not, order your Copy To-day.**

The Subscription Rate is 10/= per annum (post free).

## THE AIRCRAFT SUPPLIES COMPANY LTD

CONTRACTORS TO THE AIR BOARD.

ASCOL HOUSE, 125, LONG ACRE, LONDON, W.C.2.  
Representatives in Birmingham, Manchester, Leeds, Belfast, Northern Counties and Scotland,  
South Coast and the London District.

Managing Director—  
G. H. MANSFIELD.

WORKS—  
Little James St.

Telephone—  
Gerrard 276.

Telegrams—  
"Upeast, Rand," London.



# THE BRITISH AND COLONIAL AEROPLANE Co., Ltd.,

FILTON, BRISTOL.

CONSTRUCTORS OF —

*The "Bristol" Aeroplanes*

CONTRACTORS TO THE  
ROYAL AIR FORCE.

TELEGRAMS:  
"AVIATION, FILTON."



TELEPHONES:  
3906 BRISTOL.

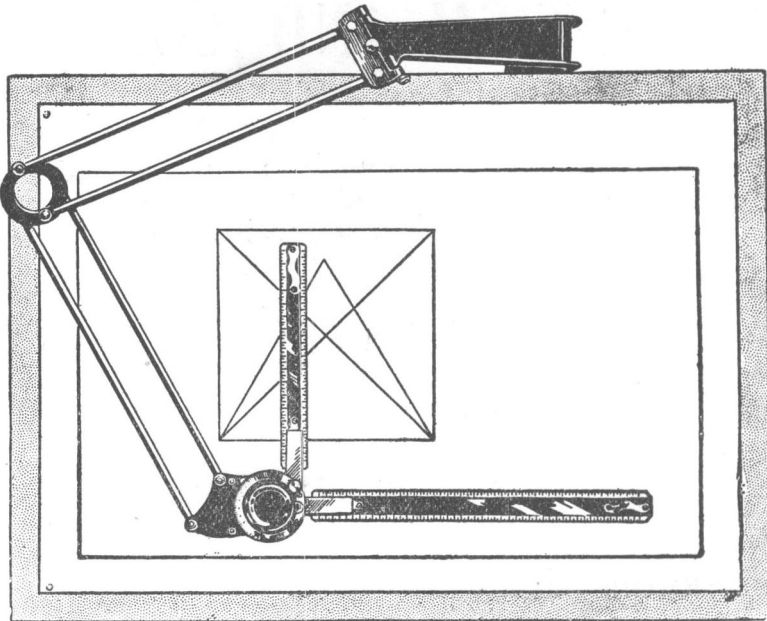

## UNIVERSAL DRAFTING MACHINES.

When time presses, the Universal Drafting Machine proves its greatest worth. It is a remarkable aid to clearness of thought, accuracy and rapidity of expression. It considerably increases the efficiency of a draftsman owing to its accuracy and easy sensitive motion.

All our draftsmen use them; we could not afford to have our drawings made by the old method.

May we send YOU particulars?

**ALFRED HERBERT LTD. COVENTRY.**



TELEPHONE:—  
OFFICE ... 912 REGENT.  
WORKS ... 4762 KENSINGTON.  
... 281-2-3 WEMBLEY.

TELEGRAMS:—  
"SOCIABLE, PHONE, LONDON."

# HOOPER & CO. LTD.

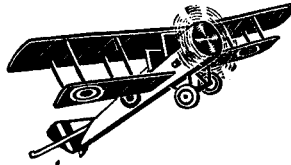

AEROPLANE BUILDERS  
TO H.M. AIR COUNCIL.



BY ROYAL WARRANT.



BY ROYAL WARRANT.



BY ROYAL WARRANT.

MOTOR BODY-BUILDERS  
AND COACHBUILDERS

BY APPOINTMENT TO

H.M. THE KING      H.M. THE QUEEN  
H.M. QUEEN ALEXANDRA

54, St. James's Street,  
PICCADILLY, LONDON, S.W.1

# JAMES W. SOUTHERN & SON L<sup>TD</sup>, MANCHESTER



**MAHOGANY,  
CEDAR,  
PINE,  
CYPRESS,**  
and Native Timbers  
in Stock.



Telegrams:  
**LIGNUM**  
Manchester

Telephones:  
253 } Central  
4600 }  
3740 City  
68 Trafford Pk.

**Woodside Engineering Company, Limited,  
Possilpark, Glasgow.**

---

# **AEROPLANE TIER RODS**

IN  
**STREAMLINE & ROUND SECTIONS**  
COMPLETE WITH  
**:: UNIVERSAL OR FORK JOINTS ::**  
**LARGE STOCKS.**

---

**PROMPT DELIVERY.**

---

**WORKS 1498 DOUGLAS (2 Lines).**

**OFFICE: 3456 CENTRAL (3 Lines).**

**(Private Branch Exchange).**

**TELEGRAMS: "FUSELAGE," GLASGOW.**

**Registered Office**

**50, WELLINGTON STREET.**

**GLASGOW.**





FOUNDED 1909.

Contractors to British and Allied Air Forces.

BUY

WAR

BONDS.

*Telephone:*  
Hampstead 7500.  
(ten lines).

*Telegrams:*  
"Hydrop Ltd., Crickle,  
London."

— HANDLEY PAGE Ltd., —  
CRICKLEWOOD, LONDON, ENGLAND.

Contractors to the Admiralty, War Office and Allied Governments.

# ARTHUR S. PORTER & CO.

## Wapping Mills, LIVERPOOL.

Telegrams and Cables—"Magasins, Liverpool."  
Codes—ABC, Engineering and Lieber's.

Telephones { 4307 } Bank.  
                  { 3613 }

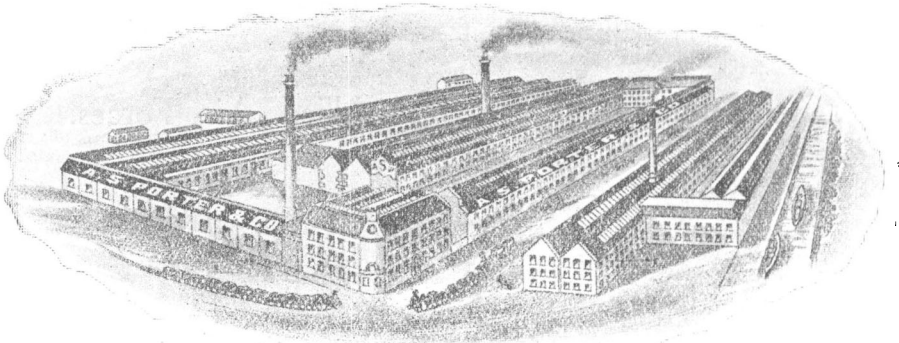

Actual Manufacturers of

**Cotton Cleaning Wastes**  
of Every Description.

**Sponge Cloths, Mops,  
Wicks, etc., Kit Webbing.**

**Aeroplane Message Bags,  
Bunting, Flags and  
Banners, Code Signals,  
Flags of All Nations.**

**Any Type of Flag made.**

**Ropes, Cordage, Lines  
and Whipping Twines**  
of Every Description

**In Manilla, Flax,  
Cotton and Hemp.**

**Aeroplane, Balloon and  
Kite Cordage a Speciality.**

**Cotton and Linen Canvas,  
Tent, Marquee and  
Tracing Lines.**

Shipping Orders a Speciality. Prompt Deliveries and Shipments.

LARGE STOCKS ALWAYS READY.

*Correspondence invited in French, Spanish and Portuguese.*

# GOOD CASTINGS

ARE <sup>231.30</sup> ESSENTIAL TO YOUR  
AIRCRAFT PRODUCTION.



We are Specialists in—

CASTINGS TO  
Air Board Specifications.

**B<sub>2</sub>**

Gun Metal.

**B<sub>8</sub>**

Phosphor Bronze.

**B<sub>9</sub>**

Manganese Bronze.

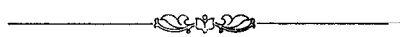

*Send Inquiry to-day . . .*

## NON-FERREOUS CASTING CO.

**Dept. A. BROAD STREET,**

# BIRMINGHAM.

Telephones:  
2716 2717  
MIDLAND.

Telegrams:  
"MANGBRONZ,  
BIRMINGHAM."

# CLAUDEL HOBSON CARBURETTORS

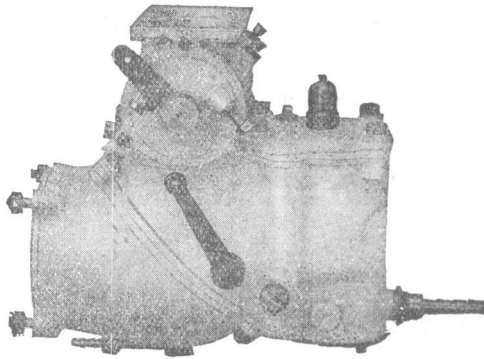

**H. M. HOBSON, LTD.,**  
29, Vauxhall Bridge Road,  
LONDON,  
S. W. 1.



**WILLANS' HIGH-GRADE CASTINGS**

SPECIALISTS IN

**ALUMINIUM-ALLOY**

**AERO-ENGINE CYLINDERS & CRANKCASES**

**CAST IRON CYLINDERS**

**PISTONS & PISTON RING POTS  
FOR MOTOR ENGINES.**

**YELLOW METAL CASTINGS BY OUR "EATONIA" PROCESS  
BEARING BUSHES, HIGH TENSILE RODS, ETC.  
CAST IRON STICK BY SPECIAL PROCESS—REDUCED POROSITY.**

**WILLANS & ROBINSON, LTD.,  
RUGBY.**

Telegrams "WILLANS, RUGBY."

Telephone { 112 } RUGBY.  
                  { 113 }  
                  { 114 }

# AERATORS, Limited.

PRANA WORKS, EDMONTON, LONDON, N.18.

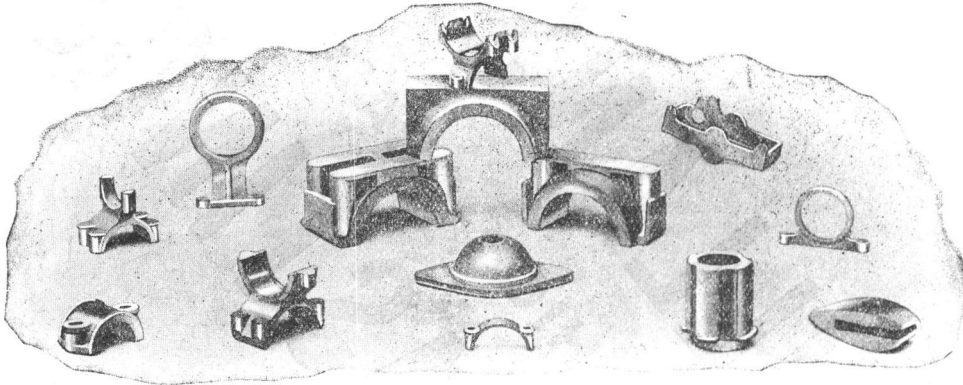

**ALUMINIUM DIE CASTINGS for ALL PURPOSES.**

*Speciality—*

ALUMINIUM CASTINGS for AERO ENGINES,  
FIELD TELEPHONES, Etc., Etc.

*'Grams: "DOCIMACY-OX, LONDON."*

# AUTO-RADIATORS LTD.

CONTRACTORS TO H.M. GOVERNMENT.

MANUFACTURERS OF

RADIATORS, TANKS, COWLS,

AND ALL CLASSES OF

SHEET METAL PARTS

FOR

AIRCRAFT.

TO A.I.D. INSPECTION.

**MANETTE STREET, CHARING CROSS ROAD,  
LONDON, W. 1.**

*'Phone: REGENT 2362.*

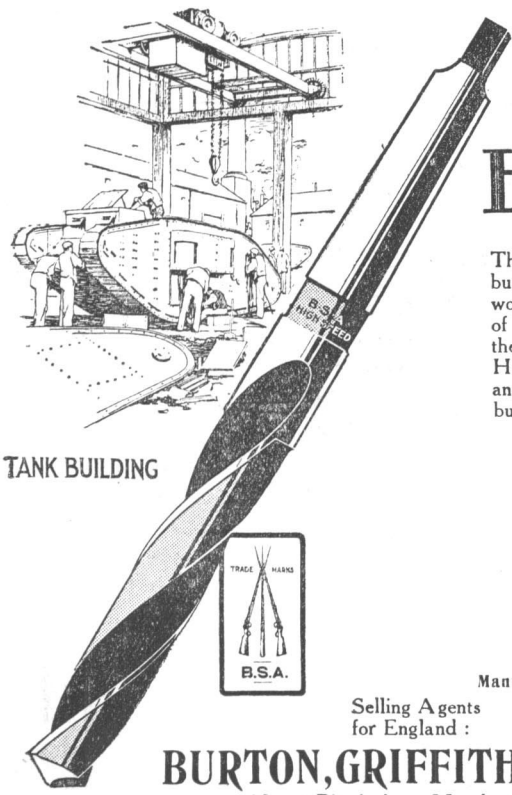

# Drills for Every Purpose

There are nearly 5,000 separate drilling operations required in the building of a Tank, and it is self-evident that continuous heavy work of this character constitutes a tremendous test on the efficiency of the drills employed. Accuracy, speed and reliability are among the qualifications a tool must possess, and it is because B.S.A. High Speed Steel Twist Drills have proved unequalled from these and all points of view that they are so widely used on Tank building and other work of National importance.

## B.S.A.

### TWIST DRILLS

Manufactured by the Birmingham Small Arms Co., Ltd., Birmingham.

Selling Agents  
for England :

**BURTON, GRIFFITHS & Co., Ltd.,** 1, Ludgate Square, London,  
Ludgate Hill, E.C.4.  
Also at Birmingham, Manchester, and Glasgow.



CONTRACTORS TO THE  
WAR OFFICE AND ADMIRALTY.

LONDON OFFICE :  
27, BUCKINGHAM GATE. S.W.1.  
TEL.: VICTORIA 3688.

WORKS & OFFICES :  
THE HYDE, HENDON, N.W.9.  
TEL.: KINGSBURY 220.

TELEGRAMS : " AIRMANSHIP, HYDE, LONDON. "



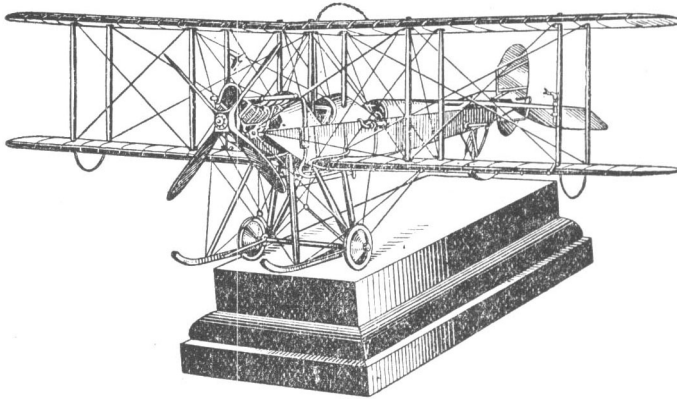

# Aeroplane Models

THE Silver Model of an Aeroplane illustrated shows how technical knowledge and skilled workmanship are allied in the models produced by the Goldsmiths and Silversmiths Company.

Infinite care is taken to ensure every detail being accurate and of proper proportions, and to reproduce an exact replica of the original.

Models can be prepared from the original or from a photograph. Estimates and designs will be submitted free upon application.

***The Goldsmiths and Silversmiths Company have no other establishments in Regent Street, Oxford Street, or anywhere else in London, and no branches in the Provinces or Abroad.***

THE  
**GOLDSMITHS & SILVERSMITHS**  
**COMPANY LTD.** *with which is incorporated The Goldsmiths' Alliance Ltd. Established 1731*

**112, Regent Street, London, W. I.**



# PALMER

## Landing Wheels and Tyres.

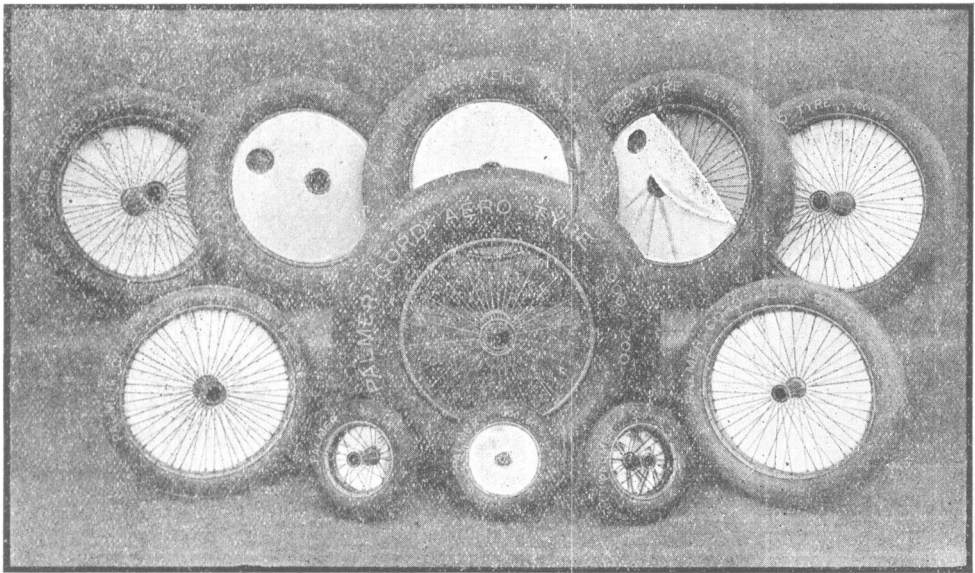

### STANDARD SIZES:

Tyre Sizes.	Wheel No.	Hub.		Track Line.	Tyre Sizes.	Wheel No.	Hub.		Track Line.
		Length	Bore.				Length.	Bore.	
300 x 60	16	m/m	m/m	Central	750 x 125	33	m/m	m/m	Central
"	17	111.12	25.4	Central	"	77	150.	38.09	Central
450 x 60	30	72.39	12.7	Central	"	92	178.	44.45	132/46
575 x 60	21	89.	31.75	Central	"	95	185.	55.	135/50
"	34	160.	28.	Central	"	96	185.	55.	Central
"	111	150.	31.75	104/46	"	99	178.	38.89	132/46
650 x 65	78	150.	38.09	104/46	"	112	150.	40.	Central
"	79	178.	44.45	132/46	800 x 150	36†	185.	55.	135/50
"	100	178.	38.09	132/46	"	40†	185.	60.32	135/50
"	101	178.	31.75	132/46	"	41†	185.	55.	Central
600 x 75	21	160.	28.	Central	"	82	185.	55.	135/50
"	34	150.	31.75	104/46	"	85	185.	55.	Central
"	111	150.	38.09	104/46	"	106	185.	47.62	135/50
700 x 75	78	178.	44.45	132/46	"	205†	185.	60.32	Central
"	79	178.	44.45	Central	1000 x 150	97	250.	65.4	Central
"	100	178.	38.09	132/46	"	102	185.	55.	125/60
"	101	178.	31.75	132/46	"	201	185.	60.32	125/60
700 x 100	33	150.	38.09	Central	900 x 200	107	185.	55.	Central
"	77	178.	44.45	132/46	"	108	185.	55.	125/60
"	92	185.	55.	135/50	"	120	185.	66.67	125/60
"	95	185.	55.	Central	"	202	185.	60.32	Central
"	96	178.	55.	132/46	"	208	185.	60.32	125/60
"	99	178.	38.89	132/46	1100 x 200	52	185.	55.	116/69
"	112	150.	40.	Central	"	57	185.	55.	Central
650 x 125	119	178.	55.	132/46	"	203	185.	60.32	116/69
					"	204	185.	60.32	Central

† Wheels Nos. 36, 40, 41 and 205 are of stronger type than the other wheels for 800 x 150 tyres

## THE PALMER TYRE LIMITED,

Contractors to the Admiralty, the War Office, and the Ministry of Munitions.

119, 121, 123, SHAFTESBURY AVENUE, LONDON, W.C.2.

Telegrams: "TYRICORD, WESTCENT, LONDON."

Telephone: GERRARD 1214 (Five Lines).

PARIS: 24, Boulevard de Villiers, Levallois-Perret.

# HIDE GLUES

FOR  
AIRSCREWS  
AND  
AIRCRAFT CONSTRUCTION.

APPROVED GLUES.

Manufacturers—  
WM. OLDROYD & SONS, Ltd.,  
9, MINCING LANE,  
LONDON,

TELEPHONE  
4978 Avenue.

E.C. 3.

# WYCOMBE AIRCRAFT CONSTRUCTORS, Ltd.

Contractors to H.M. Government.

Telegrams :—Aircraft, High Wycombe.

Telephones :—High Wycombe 84 and 235.  
(Stores—High Wycombe 120.)

# HIGH WYCOMBE.

ORIGINAL  
MANUFACTURERS OF  
STREAMLINE

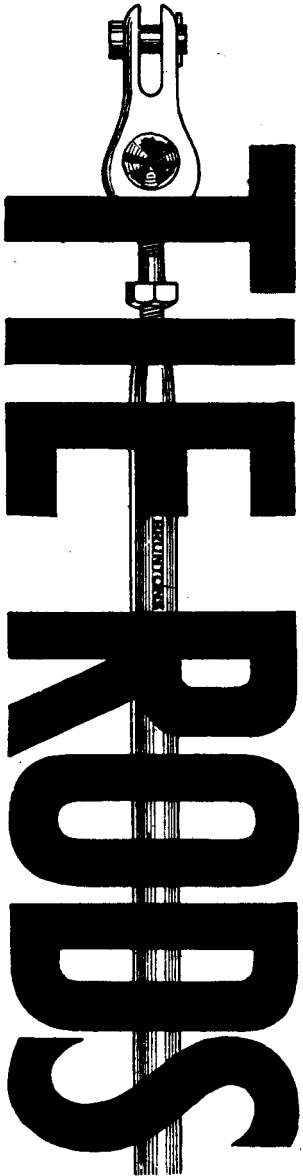

BRUNTONS  
MUSSELBURGH  
SCOTLAND. —

# ALUMINIUM CYLINDERS

*Water and Air Cooled.*

.....  
*Specialists in High-Class  
Aluminium Castings for  
All Trades, and General  
Aero and Motor Engine  
Castings. : : :*

# CAST IRON CYLINDERS

.....  
*Water and Air-cooled for  
Aero and Motor Engines.*

*All Castings to Government Specification.*

## WILLIAM MILLS, Ltd.

Aluminium and Iron Founders

ATLAS WORKS  
GROVE STREET



### BIRMINGHAM



# Vertical Boring and Recessing Machine.

**Specially designed for accurate work.**

*Type PF*

*Write for  
Further Particulars.*

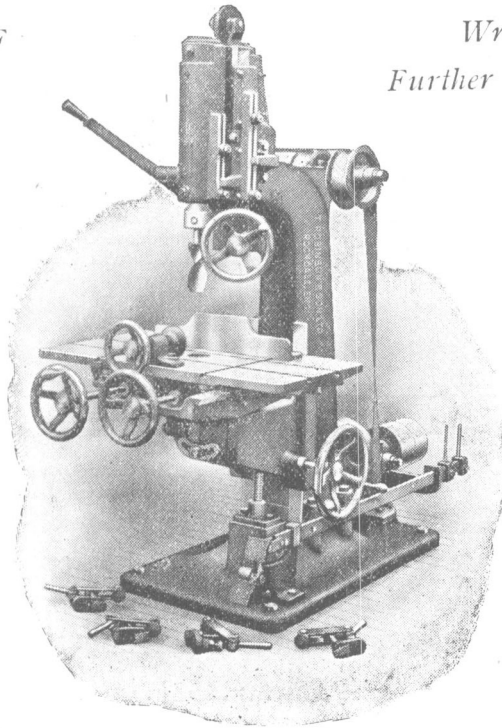

**For boring, drilling, and recessing the bosses  
of propellers, etc.; half lapping the laminations;  
recessing and drilling the spars, etc.**

**Thos. Robinson & Sons**  
LIMITED  
ROCHDALE

## Selecting Your Car.

# Humber

### MOTOR CARS

Beautiful in Design  
Mechanically Correct  
Thoroughly Modern

Humber Limited

London : 32, Holborn Viaduct, E.C.1.

Repair Works : Canterbury Rd., Kilburn, N.W.

Southampton : 25 and 27, London Road.

Works : Coventry.

The need for economy will determine your choice. Only an Efficient Car can be economical.

The HUMBER 10 h.p. and 14 h.p. after-war models will satisfy the most exacting demand. The standard of accuracy and finish in all mechanical details eliminates friction, promoting smooth running, and ensuring the minimum expense for fuel and tyres.

These features are combined with moderate first cost and must exert their influence in favour of the HUMBER.

A. 187

## Speciality—HIGH GRADE ALUMINIUM ALLOYS

HIGH TENSILE, FOR AERO WORK & OTHER SPECIAL REQUIREMENTS.

### T. J. PRIESTMAN

✦ Metal Manufacturer ✦  
and General Caster in all Metals

**OFFICIAL REFINER of ALUMINIUM**  
**to H.M. MINISTRY OF MUNITIONS**



**Cupro Foundry - Leopold Street - Birmingham**

Established 1872. Telephones: Works, Midland 281; Offices, Midland 282

*Buyer of Every Description of Aluminium Scrap and Swarf.*



For many years Engineers who used leather for clutches and brakes have substituted **FERODO FRICTION SURFACES** which are vastly more efficient.

Over twenty years ago we invented Ferodo Fabrics. Since then, by specialising on the one product, and as a result of practical experience, we have so improved them that they are to-day readily acknowledged to be the finest friction surfaces in the world.

They are entirely unaffected by water, oil or acid, and absorb more foot lbs. of energy per square inch than any other material known. Wood and leather linings char and quickly wear out. Ferodo Fabrics are spark-proof and non-inflammable.

*Ferodo Fabrics have the name stamped on each foot. Look for it when ordering your new linings.*

# FERODO

## FRICTION SURFACES

*Contractors to the War Office and Admiralty, London  
General Omnibus Company, and Underground Electric  
Railways of London and Paris, List "A.J.," from*

**THE HERBERT FROOD CO., LTD.**

**Works: CHAPEL-EN-LE-FRITH.**

'Phone—19 and 20 Chapel.

Wires—"Friction, Chapel."

Depots at London, Birmingham, Belfast, Bristol, Cardiff, Edinburgh, Glasgow,  
Liverpool, Manchester and Newcastle.



# FERODO

## Friction Surfaces.

# G. D. PETERS & Co., LIMITED.

WINDSOR WORKS,  
SLOUGH,  
BUCKS.

---

Contractors to  
H.M. WAR OFFICE AND AIR MINISTRY.

---

Telephones :  
SLOUGH 201, 202, 203.  
Victoria 2900, 2901.

London Office :  
15, Dean's Yard, Westminster,  
S.W.1.

Telegrams :  
PETERS, SLOUGH  
Peters, London.

## DUGARD BROTHERS, LTD.

---

**ROLLED METALS.** Brass, Copper, Bronze,  
Gun Metal, etc., in Sheets,  
Rolls, Strips, Foil and Circles.

**TUBES.** Solid drawn Brass and Copper Tubes, for Oil  
Pipes, Petrol Pipes, Radiators and all Aircraft  
requirements. Also Mandril drawn Tube for  
Scientific and Optical Instruments.

**RODS.** Brass, Gun Metal and Bronze. Round, Hexagon  
and Square.

---

VULCAN MILLS, BRIDGE STREET WEST,  
BIRMINGHAM.

Telegrams : "VULCAN," BIRMINGHAM.

Telephone : CENTRAL 98.

# Propellers : ONLY :

OUR TELEPHONE NOS. ARE NOW 20547 & 20548.



**W. D. ODDY & Co.,**  
**Globe Road, Holbeck, Leeds.**

Telegrams : "AIRSCREWS, LEEDS."

Telegraphic Address: "Barr, Kilmarnock."

Telephone No. 71 Kilmarnock.

# BARR, THOMSON & Co., Ltd.,

Netherton Ironworks, Kilmarnock, Scotland.

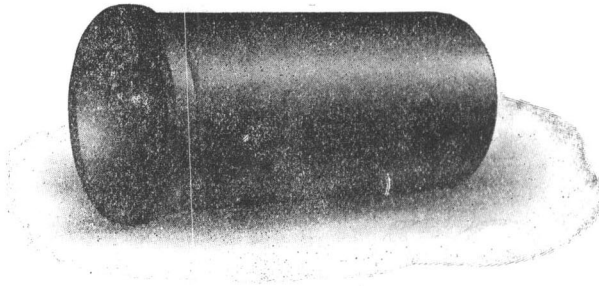

MAKERS OF STAMPED STEEL CYLINDER  
LINERS FOR AEROPLANE ENGINES,  
and  
All Kinds of Hydraulic Stampings and Forgings.

What's in a name? There's  
Springs and Presswork in

**TERRYS**

as well as Washers, Wirework, complete Cables for control of Cut Outs, etc.,  
Flexible Shafts, and Light Capstan Practice.

We have a flexibility of organisation that readily adapts itself to all requirements.

We shall be glad to receive orders and arrange for contract deliveries.

**HERBERT TERRY & SONS, LTD.,** The Spring & Press  
Work Specialists, **REDDITCH, ENG.**





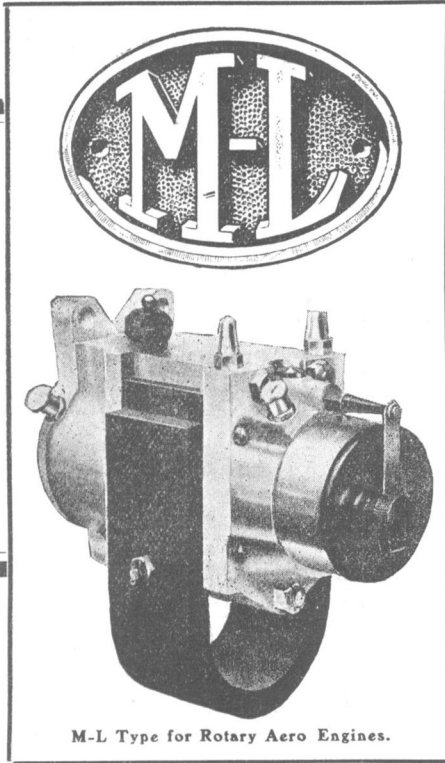

More Spark Energy  
and Sparks at much  
lower speeds than  
any pre-war mag-  
netos of equal size  
and weight.

The M-L Magneto Synd., Ltd., Coventry.



# SANKEY

*Undershields  
& other Light  
Stampings  
for Aeroplanes  
Petrol Tanks  
Sumps, Bonnets,  
Cowls*

## Pressings & Stampings

WE have special facilities for turning out combinations of stamped or hydraulically pressed, rivetted and welded work of all descriptions, with or without machining, of any thickness from 20 gauge sheets to  $\frac{3}{4}$  in. plates, in steel or other material.

*Let us know your requirements and we will quote you.*

**JOSEPH SANKEY & SONS LTD.**  
Wellington, Shropshire.

# W. G. TARRANT,

*Contractor to Air Board.*

*Aircraft Head Offices :*

BYFLEET, SURREY.

TELEPHONE : BYFLEET 1.

.. 2.

.. 3.

*London Offices :*

CLOCKHOUSE,

ARUNDEL STREET,

STRAND, W.C.

TELEPHONE : GERRARD 8362.

## FERRO-ALLOYS AND METALS

**FERRO-SILICON** 45/50% Silicon.

**COBALT METAL**

**FERRO-CHROME** 70/75% Chromium, 4/6% Carbon.

*Immediate delivery from Stock.*

**MAGNESIUM METAL** In Sticks

**MAGNESIUM COPPER**

The best deoxidiser and scavenger for Copper, Bronze and Phosphor Bronze Castings.

**ANTIMONY**

**CADMIUM**

**COPPER MANGANESE**

**COPPER-SILICON**

**FERRO-COPPER**

**COPPER-VANADIUM**

**FERRO-MOLYBDENUM**

**NICKEL**

**FERRO-MANGANESE**

**PHOSPHOR-COPPER**

**PHOSPHOR-TIN**

**FERRO-TANTALUM**

**FERRO-URANIUM**

.. **TUNGSTEN**

.. **VANADIUM**

.. **TITANIUM**

**ZIRCONIUM**

**POLISHING POWDERS, PLUMBAGO, MANGANESE OXIDE.**

**EVERITT & CO., 40, CHAPEL STREET,**

**LIVERPOOL.**

Telephone No. 1134 CENTRAL.

Telegraphic Address—"PERSISTENT."

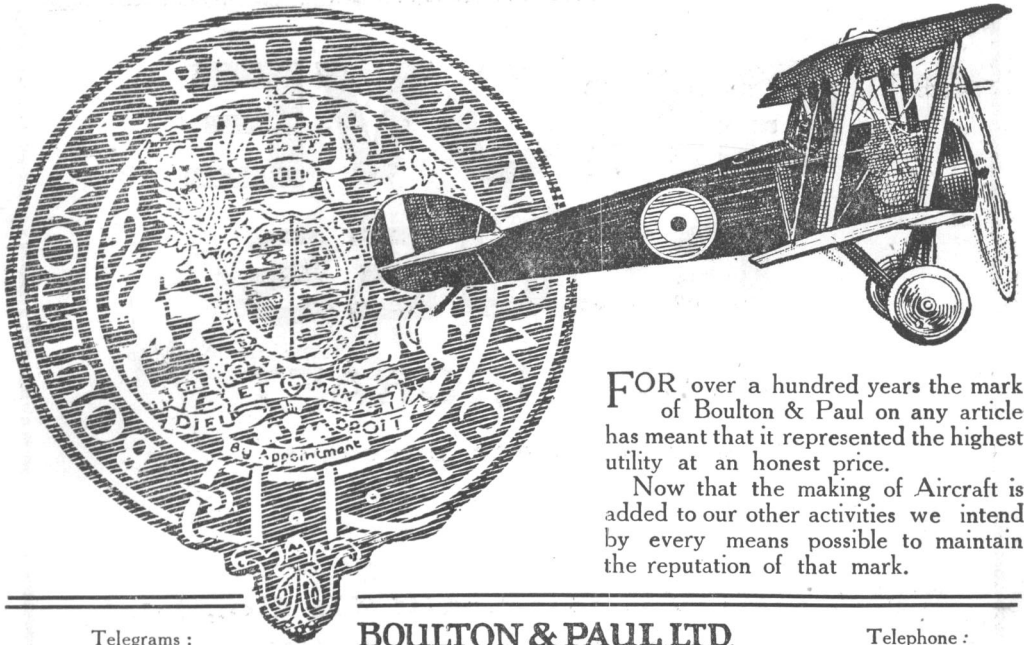

FOR over a hundred years the mark of Boulton & Paul on any article has meant that it represented the highest utility at an honest price. Now that the making of Aircraft is added to our other activities we intend by every means possible to maintain the reputation of that mark.

Telegrams :  
Aviation, Norwich.

**BOULTON & PAUL LTD.**  
*Makers of Aircraft*  
**NORWICH.**

Telephone :  
Norwich 851.

**BURTON, DELINGPOLE & CO**

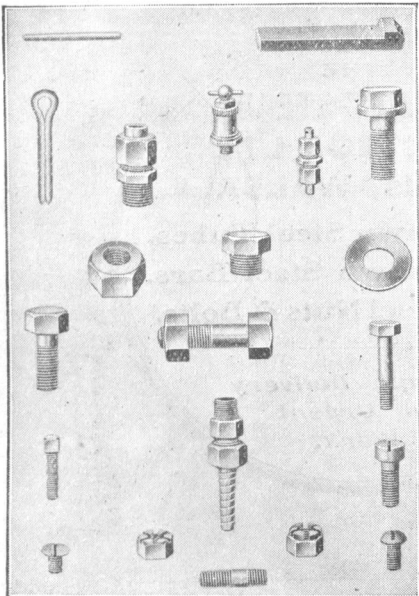

MANUFACTURERS OF  
**CAPSTAN &  
AUTOMATIC WORK**  
IN BRASS, STEEL, GUNMETAL, ETC.,  
FOR ALL BRANCHES OF THE  
**MOTOR & AEROPLANE INDUSTRIES.**

**DROPFORGINGS**

STAMPINGS ONLY OR FINISHED—  
MACHINED TO CUSTOMERS' REQUIREMENTS.

**HEAD OFFICES : MOSELEY ST., BIRMINGHAM.**  
**WORKS : BIRMINGHAM & OLD HILL (STAFFS).**



# GROVE GLUES

FOR AIRCRAFT  
and all other purposes.

THE GROVE CHEMICAL Co., Ltd.,  
APPLEY BRIDGE, near WIGAN.

Telegrams—"CROWN, APPLEY BRIDGE."

Telephone—12 PARBOLD.

THE  
TALBOT-STEAD  
TUBE CO., LTD.,  
Birchills, WALSALL.

Solid Drawn Steel Tubes.  
Bright Drawn Steel Bars.  
Bright Steel Nuts & Bolts.

Prompt Delivery  
for Urgent  
Work.

Tele-  
phone:  
276  
AND  
277.

Tele-  
grams:  
Talbot,  
Walsall



**DESIGN**

The Design of the  
Pre-War

**Beardmore**  
**AERO ENGINE**

Placed in advance of all others, which proud position it holds to-day. To-morrow will reveal further advance.

Watch **BEARDMORE** Developments.

**THE BEARDMORE AERO ENGINE LIMITED,**

London Showrooms and Depot:

**112, Great Portland Street, London, W.I.**

Telephone: 238 GERRARD.

C.D.C.

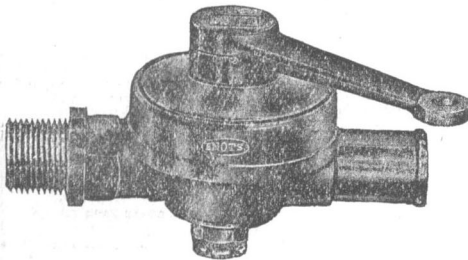

Trade Mark **ENOIS** Registered.

**PATENT CORK-DISC SEATED  
PETROL COCKS**

**POSITIVELY PETROL TIGHT UNDER PRESSURE.  
WILL NEITHER SEIZE NOR SLACKEN**

A.G.S. 408, 409 & 410. Patent Number 102850.

THE ENTIRE OUTPUT OF THESE AND OTHER  
**AIRCRAFT COMPONENTS**

IS AT PRESENT ABSORBED BY  
**THE AIR BOARD, ADMIRALTY & WAR OFFICE.**

ILLUSTRATED CATALOGUE WILL BE SENT TO RECOGNISED CONTRACTORS  
BY THE MANUFACTURERS and  
SOLE PATENTEES

**Benton & Stone Ltd.**

**ENOTS WORKS,  
BIRMINGHAM,**



**ENGLAND.**

Telephone :  
Central 1449.

Cable & Telegraphic Address :  
"Cantonla," Sheffield.

THE  
**CANTON STEEL & TOOL CO.,**  
CANTON STEEL WORKS,  
CORNISH STREET, SHEFFIELD.

Manufacturers of . . .

**"Canton" High Speed Steel.**

CAST & TOOL STEELS for EVERY DESCRIPTION of TOOLS.

**AIRCRAFT STEELS to A.I.D. Inspection and Tests.**

Contractors to H.M. Government.

On "Lloyd's Register."

Hors Concours Membre du Jury : Brussels International Exhib'tion, 1910,  
Grand Prix London, 1908, and Buenos Aires, 1910.

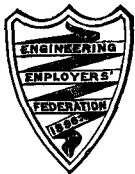

Telegrams :  
JONAS,  
SHEFFIELD.

REGISTERED



TRADE MARKS.

Telephone :  
No. 4660.  
PRIVATE BRANCH  
EXCHANGE.



**JONAS & COLVER, LIMITED,**

Manufacturers of Steel of every description, including  
**HIGH GRADE NICKEL STEEL and FORGINGS**  
for Naval and General Marine Purposes.

Special Heat Treated Alloy and other Steels for Aircraft and  
Automobile Purposes.

IMPORTANT SPECIALITIES :

**S. S. G.**

**A SPECIAL NICKEL CHROME GEAR STEEL.**

FOR AIR OR OIL HARDENING. When treated this steel has exceedingly tough properties and is specially suitable for Gear Wheels, Connecting Rods, etc.

**S. G. W.**

**A NICKEL CHROME STEEL in 4 GRADES.**

Eminently suitable and strongly recommended for Gears, Crankshafts, and other highly stressed parts, and having exceptional machining qualities. Combines unusually heavy shock-resisting and wearing properties with silent running.

**G. P. S.**

**A HIGH GRADE ALLOY CASE HARDENING STEEL**

for severely strained parts, such as Gear Wheels, Gudgeon Pins, etc.

**Continental Steel Works and Novo Steel Works, Sheffield.**

**S****ANDERSON** **B****ROTHERS**

**& N****EWBOULD, LTD.,**

**ATTERCLIFFE FORGE and ROLLING MILLS,  
SHEFFIELD.**

---

**Makers of High-Class**

**AIRCRAFT  
STEELS**

**Either Rolled or Heat Treated  
to**

**AIR-BOARD SPECIFICATIONS.**

---

**Ask for our Special Book on**

**HIGH TENSILE STEELS.**



# BRITISH MADE CHUCKS.

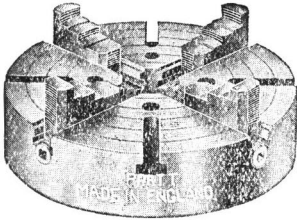

## Independent 4-Jaw Chucks.

**Reversible Jaws and Heavy Bodies.**

Screws have Double-thrust Bearings (10in. size and upwards).

STANDARD SIZES:— 4½, 5, 6, 8, 9, 10, 12, 14, 15, 16, 18, 20, 22 and 24in. diam.

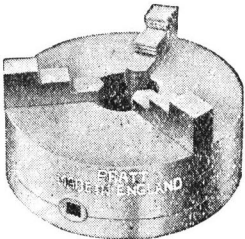

## 3-Jaw Geared Scroll Chucks.

**Self-Centring.**

SIZES IN PROGRESS : 5in., 6in., 7½in. and 9in. diam.

With One or Two Sets of Jaws as required.

**Price Lists on Application.**

Can be had from all Merchants and Dealers.

Manufactured by—

## F. PRATT & CO., LTD., HALIFAX, ENG.

Telegrams : "Pratt, Halifax."

Telephone : No. 161.

# W. CANNING & Co.,

MANUFACTURERS OF

## PLANT AND MATERIALS

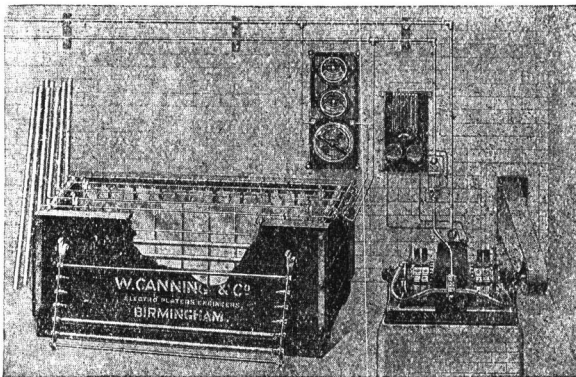

FOR

**ELECTRO-ZINCING,  
NICKEL PLATING,  
TIN PLATING,  
LEAD PLATING,  
COPPER PLATING,  
BRASS PLATING,  
SILVER PLATING,**

etc., etc.

**POLISHING MACHINERY AND MATERIALS.  
ENAMELLING AND DRYING STOVES.  
LACQUERING AND DRYING TABLES.**

## Great Hampton St., BIRMINGHAM.

18-20, St. John's Square, Clerkenwell, LONDON.

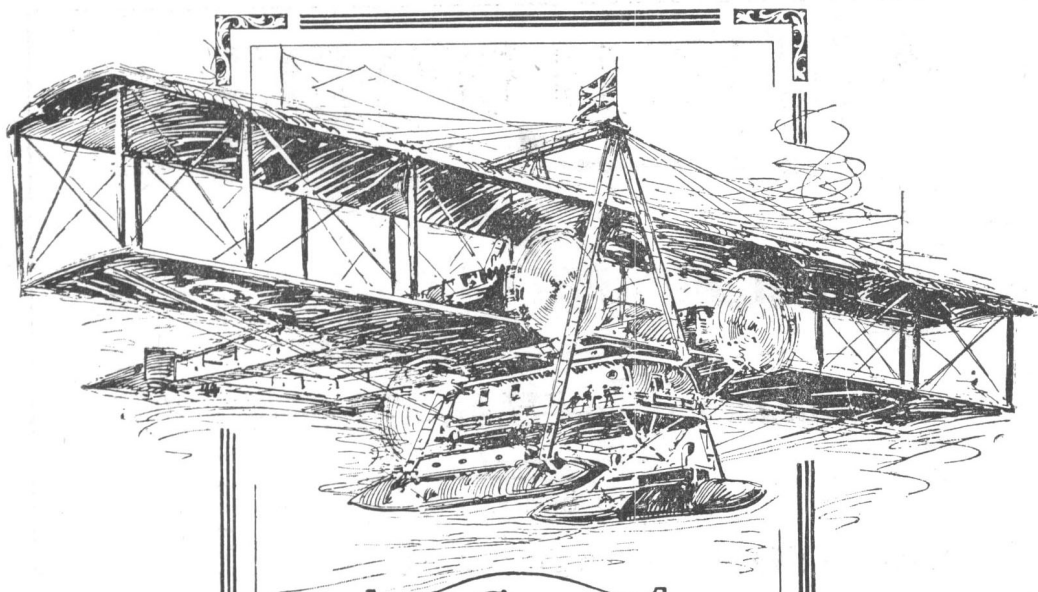

*Speed with Safety.*

IT is the policy of the Graham-White Company to stimulate in every way possible the use of aircraft as vehicles for high-speed travel; and they are now in a position to accept orders for large multi-engine machines, carrying as many as twenty-four passengers, or several tons of goods; also special high-speed craft for the transport of express air-mails in addition to touring and pleasure machines for the use of the private purchaser.

*The*  
**Graham-White**  
COMPANY



LTD.

*Head Office and Works:*

THE LONDON AERODROME, N.W.9.

Telegrams: "Volplane, Hyde, London."

Telephone: Kingsbury 120 (7 lines).

*London Office:*

12, REGENT STREET, PALL MALL, S.W.1.

Telephone: Regent 2084.

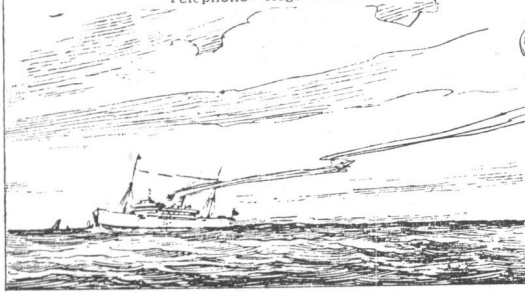

# “ NIEUPOORT ”

— AND —

## General Aircraft Company, Ltd.

*Contractors to H.M. Government.*

REGISTERED OFFICE AND WORKS :

**LANGTON ROAD, CRICKLEWOOD,  
LONDON, N.W.2.**

Telephone (3 lines) :  
WILLESDEN 2455.

Telegrams :  
NIEUSCOUT, CRICKLE, LONDON

### A FEW LABOUR SAVING DEVICES

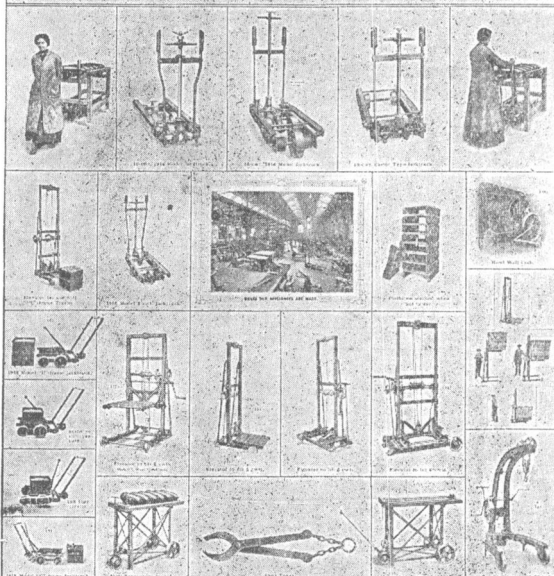

SOLE PATENTED & MADE BY  
**JOHN T. HARDAKER, LTD.,** DOWLING IRON WORKS, PRINCE LANE, BRADFORD.  
Also in LONDON, BELFAST, GLASGOW, BIRMINGHAM,  
BOMBAY, MELBOURNE, MONTREAL, &c.

### HARDAKER'S Patent **JACKTRUCKS.**

Specially designed for transporting  
Aeroplane Engines on working  
benches.

Used by all the leading Aero  
Engine makers and Aircraft  
Stores, etc.

Write for full Illustrated  
Catalogue to

(Sole Makers and Patentees):

**JOHN T. HARDAKER,  
LTD.,**

(AERO TRUCK DEPT.),

**Bowling Ironworks,  
BRADFORD, YORKS.**

Telegrams: "GIMP, BRADFORD."  
Telephone: 120 DUDLEY HILL.





**Bowden**  
**Wire Ltd.**  
London

TRADE MARK

Manufacturers of the world-famous Bowden  
Wire Mechanism and Controls.  
*Established 1897.*

WITH the advent of the long-hoped-for peace, we are able to announce our preparedness to resume the manufacture of our pre-war products.

While still engaged upon several war adaptations of BOWDEN WIRE MECHANISM, the great extension of premises, plant and machinery effected during the war makes it possible for us to deal promptly with fresh orders or all kinds of pre-war goods.

We invite enquiries.

*Trade Marks and Names :*

Bowdensolo	Bowdenite
Bowdenoir	Bowdensilver
Bowdenamel	Bowdenbrass

**Victoria Road, Willesden Junction, N.W. 10.**

*Godbolds.*

**Thomas Andrews & Co. Ltd.**

—ROYDS WORKS AND—  
HARDENITE STEEL WORKS **SHEFFIELD.**

High Class **ALLOY STEELS**

MADE TO AIR BOARD AND E.S.C. SPECIFICATIONS

**FOR AIRCRAFT AND  
AUTOMOBILE CONSTRUCTION**

Telegrams—Bits, B'ham.

ESTABLISHED 1800.

Telephone—355 Northern.

# R. COOPER & SONS LTD.

10 YEARS' EXPERIENCE IN

THE MANUFACTURE OF

AIRCRAFT

METAL

DETAIL FITTINGS, COMPONENTS,

TANKS,

EXHAUST PIPES, COWLINGS, ETC.

**40, High Street, Aston New Town, BIRMINGHAM.**

Contractors to the Admiralty and Air Board.



## THE CENTRAL AIRCRAFT COMPANY,

DESIGNERS AND CONSTRUCTORS  
OF AIRCRAFT.

Office and Works:

**KILBURN, N.W.6.**

Telegrams: AVIDUCTION, PHONE, LONDON.

Telephone: HAMPSTEAD 4403, 4404.

**BRIGHT  
GOLD ROLLED  
STEEL STRIP.**

---

**BRIGHT  
DRAWN STEEL  
BARS.**

**FOR ALL —  
PURPOSES.**

**W. WESSON & CO., LTD.,  
VICTORIA IRON & STEEL WORKS,  
MOXLEY, WEDNESBURY.**

Telegrams—  
"IRON, WEDNESBURY."

On Admiralty, War Office and  
other Government Lists.

Telephone—  
62 WEDNESBURY.

TRADE



MARK.

.. THE ..  
**WHITECROSS CO. LTD.,**  
**WARRINGTON, ENGLAND.**

Telephone:  
 Nos. 9, 10 & 11,  
 Warrington.

Telegram:  
 "Whitecross,  
 Warrington."

BRIGHT DRAWN PATENT STEEL ROUND  
 WIRES TO A.I.D. SPECIFICATION  
 FOR THE MANUFACTURE OF  
 AEROPLANE TIE RODS  
 AND STREAMLINE  
 SECTIONS.

TRADE



MARK.



**W. H. ALLEN SON & CO. L<sup>TD.</sup>**

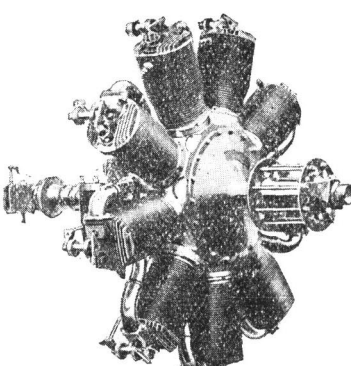

**AIRCRAFT  
 ENGINES**

**QUEEN'S ENGINEERING WORKS, BEDFORD.**



## GOLD MILD STEEL PUNCHINGS.

THE multiplicity of special contracts entrusted to us by various Government Departments during the period of the War, has necessitated the laying down of a large number of presses for punchings of many varied descriptions, with the result that the Company now has at its command the most up-to-date plant in the Country for this class of work.

Inquiries are invited from Manufacturers of Motor, Aero and other Engineering Fitments, and quotations will be given for prompt delivery for large or small punchings in bulk quantities.

These cold punchings are infinitely superior to hot stampings. Wear and tear of machine tools reduced to a minimum.

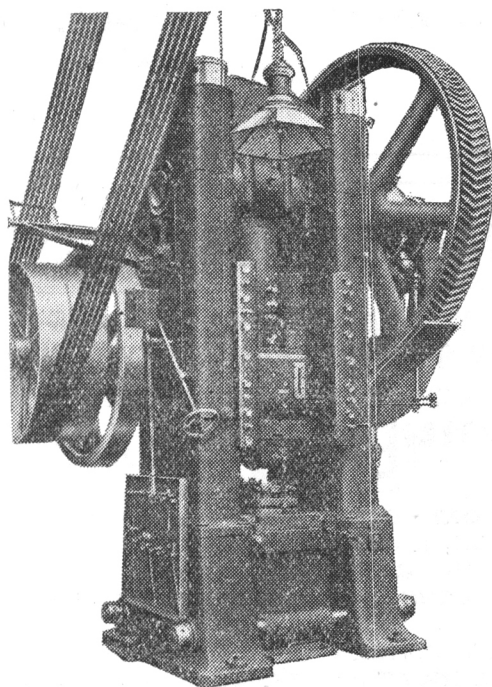

**THE SHEFFIELD SILVER PLATE & CUTLERY**  
CO., LTD.,  
**PRIESTLEY STREET, SHEFFIELD.**

Telegrams: "POWER, SHEFFIELD." Telephone Nos.: 4797 & 4798, Private Branch Exchange.

# A · B · C

THE WORLD'S LEADING  
AERO ENGINE.

*Offices and Works :*  
**WALTON-ON-THAMES.**

## **UNITED BRASSFOUNDERS & ENGINEERS, LTD.,**

CONTRACTORS TO

**H.M. WAR OFFICE. ADMIRALTY. AIR BOARD.**

AND SPECIALISTS IN THE MANUFACTURE OF

### **AERO ENGINE PARTS & ACCESSORIES**

Such as **CONNECTING ROD** and **CAM BEARINGS.**  
**GEARBOX, CAMSHAFT** and **THRUST HOUSINGS.**  
**MISCELLANEOUS CASTINGS, GEAR WHEELS, CASINGS,**  
**BRACKETS, COVERS, BUSHES, NUTS, BOLTS** and **PLUGS, Etc.**

ALSO

**PRIMING DEVICES—Sun and Planet Motions, Etc.**  
**COPPER INLET** and **EXHAUST MANIFOLD PIPES.**

**CARBURETTORS.—AIR and OIL PRESSURE GAUGES.**

**EXTRUDED BRASS** and **BRONZE BARS (All Sections).**  
**STAMPINGS** and **SPECIAL ALLOYS.**

**EMPRESS FOUNDRY,**  
**CORNBROOK, MANCHESTER.**

Telegrams—  
"STORK," MANCHESTER.  
Telephone—3134 CENTRAL.

# H. & R. WATERFALL & BARBER,

## SHEFFIELD, ENGLAND.

Manufacturers of . . .

### “ NIAGARA ”

HIGH SPEED STEEL & TWIST DRILLS.

### “ MAGIC ”

STEEL AND FILES.

### CRUCIBLE CAST STEEL

for all purposes.

### SPECIAL STEELS

for the

AIRCRAFT & MOTOR INDUSTRIES.

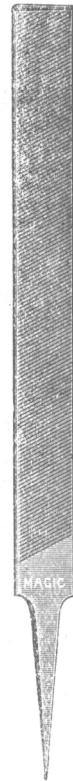
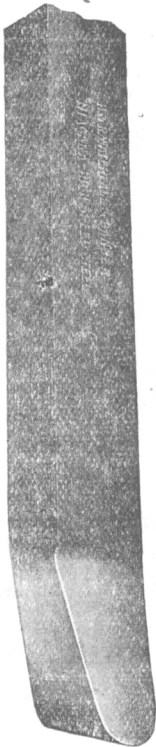

Trade Marks :—

“ NIAGARA ”

“ MAGIC. ”





TELEGRAMS: "INDUSTRIAL, SHEFFIELD."

'PHONE 4778 CENTRAL.

**Contractors to H.M. Government.**

**THE WORTHINGTON STEEL & ANNEALING CO.,**  
**ADELPHI STEEL WORKS,**  
**WATERY LANE, SHEFFIELD.**

AERONAUTICAL STEELS to A.B. Specifications.

TOOL STEELS for Turning Tools, Drills, Taps, Dies, Chisels, etc.

CASE-HARDENING STEEL.

NICKEL and NICKEL CHROME STEELS.

COLD ROLLED STRIP STEEL, Soft or Hardened and Tempered,  
 Black, Bright, Blued and Bronzed for Springs, Tapes,  
 Band Saws, etc.

Telegrams: "BLOOMS, SHEFFIELD."

Telephone: Nos. 1165, 1713, 2821 Central Sheffield.

# DUNFORD & ELLIOTT

(SHEFFIELD), LIMITED.

Attercliffe Works and Wharf, Sheffield;  
 . and 96, Bath Street, Birmingham. .

## AERONAUTICAL STEEL

TO R.A.F. TESTS.

**Speciality.**

Hollow Bars in Plain Carbon or  
 Alloy Steel for Internal Lubrication.

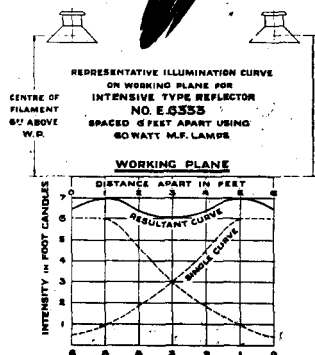
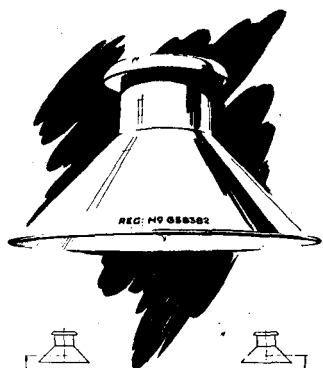
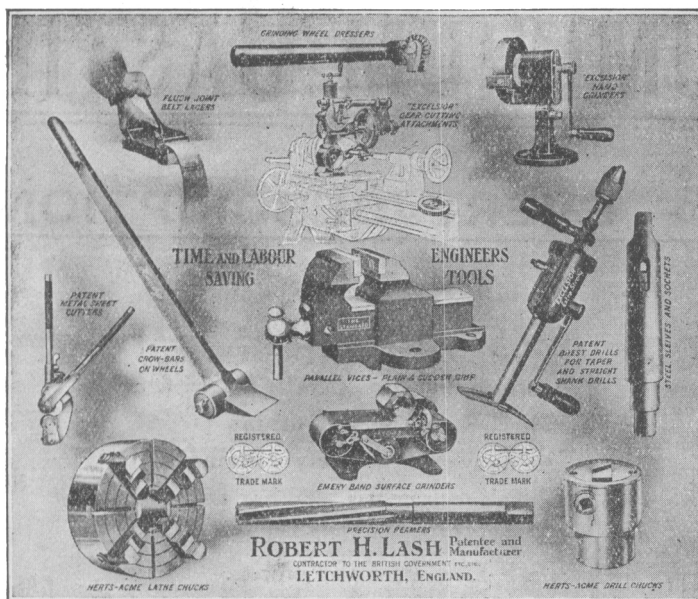

## SIMPLEX SCIENTIFIC SLIGHTING REFLECTORS

Specially designed for Factories and Aerodromes. With Simplex Steel Reflectors properly installed every ray of light is diverted to useful work, and there is no glare.

*Write for special leaflet.*

## SIMPLEX · CONDUITS · LTD.,

GARRISON LANE, BIRMINGHAM.

113-117, CHARING CROSS ROAD, LONDON.

AND AT

MANCHESTER - GLASGOW - NEWCASTLE

BRISTOL - LIVERPOOL - LEEDS

SWANSEA AND CARDIFF.

# ALUMINIUM CASTINGS

## OF EVERY DESCRIPTION.

WE MAKE  
A  
SPECIALITY  
OF  
AERONAUTICAL  
AND  
AUTOMOBILE  
WORK.

We are making many thousands of **Aluminium Die Castings** weekly under the celebrated **Cothias** process—in many cases **entirely eliminating** machining operations, and we hold the sole manufacturing rights in the British Empire for this process. ::

Chemical and Physical tests are made on our own premises, and our **Castings**, both **Sand** and **Die**, are produced under the most up-to-date and scientific :: :: methods. :: ::

Sole makers of the **Birmal Aluminium Pistons**, thousands of which are running to-day in a highly satisfactory manner : under the most severe conditions. :

HIGHEST  
CLASS  
CASTINGS TO  
GOVERNMENT  
SPECIFICATIONS  
+  
PROMPT  
DELIVERY.



**BIRMINGHAM ALUMINIUM  
CASTING (1903) CO., Ltd.,**

Cambridge Street Works,

**BIRMINGHAM.**

**SHEETS**

**WIRES**

**TUBES**

In **NICKEL SILVER,**  
**BRASS, etc.,**  
for all purposes.

**SPECIALITIES:**

**Deep Drafting Metals.**  
**Template Metal.**  
**Wires.**  
**General Rollers and Wire**  
**Drawers of Non-Ferrous**  
**Materials.**

---

**HEELEY SILVER ROLLING & WIRE MILLS, LTD.,**  
**GUERNSEY ROAD, SHEFFIELD.**

Tel. 4513 (8 lines).

Telegrams "Ixion," Sheffield.

THE  
**GNÔME AND LE RHONE ENGINE**  
**COMPANY.**

CONTRACTORS TO THE  
WAR OFFICE AND ADMIRALTY.

**LONDON OFFICES :**

27, BUCKINGHAM GATE, S.W.1, AND THE HYDE, HENDON N.W.

**WORKS :**

**BLACKHORSE LANE, WALTHAMSTOW, E.17.**

Telephone : WALTHAMSTOW 811.

**P** **FOR**  
**AERO ENGINES.**

**U**

**OIL,  
AIR,  
WATER,  
PETROL.**

MANUFACTURED BY

**M**

THE

**SELSDON**

**P**

**AERO & ENGINEERING CO., L<sup>D</sup>.**

**1, ALBEMARLE STREET,  
PICCADILLY, W.1.**

**S.**

**Anti-Friction BEARINGS**

FOR ALL PURPOSES.

TO ENSURE

ACCURACY, EFFICIENCY, AND ECONOMY,

instal ANTI-FRICTION BEARINGS made and lined under

THE WALKER-HANNA PATENTS

FOR

MOTOR CARS, ELECTRIC MOTORS, TRAMWAYS,  
AND ALL OTHER PURPOSES.

**NO MACHINING REQUIRED, absolute INTERCHANGEABILITY with  
those you are at present using.**

*Write us on any question concerning Bearings.*

**WALKER-HANNA BEARINGS, Ltd.,**

IMPERIAL WORKS, GREAT JACKSON STREET,

WEST GORTON, MANCHESTER.

Phone 85 OPENSHAW.

AGENTS—

**E. T. WHITE & CO., Albemarle Mansions, 1 Albemarle Street, Piccadilly, London, W.1.**

Every time you "Go up"-  
you run a needless risk

- if your goggles, windscreen, panels, etc., are of ordinary glass. You run the risk of the glass breaking on the least shock or impact, and when ordinary glass breaks it splinters and causes injury.

By using "Triplex" Safety Glass wherever glass is needed you eliminate this risk entirely, for nothing can make "Triplex" splinter.



**'TRIPLEX'**

THE TRIPLEX SAFETY GLASS CO., Ltd.,  
(Reginald Delpech, Managing Director)  
1, ALBEMARLE STREET, LONDON, W.1.  
Telephone—Regent 1340.  
Telegrams—"Shatterlys, Piccy, London."  
Contractors to H.M. Government

Write to-day for our Illustrated Catalogue (No. 4) describing "Triplex" and the extraordinary tests it has stood.

**COMET STEELS**

**For all High-Class Engineering Work requiring Special Steel in Alloy and plain Carbon Grades.**

**BARS. BILLETS. FORGINGS. SHEETS.**

**Output - 2,500 Tons Weekly.**

**W. GILBERTSON & CO.,**

LIMITED,

**Pontardawe Steel Works,  
Nr. SWANSEA.**

# SUTCLIFFE.

WARMING  
AND VENTILATING  
PLANTS

FOR DOPE ROOMS.

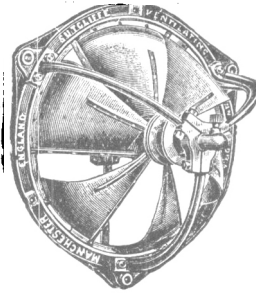

DUST COLLECTING  
PLANTS

FOR GRINDING and  
POLISHING SHOPS.

**CONTRACTORS TO THE WAR OFFICE AND ADMIRALTY.**

Ask for copy of New Booklet, just issued, "The Warming and Ventilating of Dope Rooms and Aeroplane Factories to satisfy Home Office requirements." Sent post free on request.

## SUTCLIFFE VENTILATING & DRYING Co., Ltd.,

Cathedral Gates,  
**MANCHESTER.**

T.N.—3920 City Manchester.

T.A.—Ventilabro, Manchester.

## MARTINO'S TREATING AND TESTING WORKS LTD.

### HEAT TREATMENT OF STEEL TO AIR BOARD SPECIFICATIONS.

Telephone:  
No. 845  
COVENTRY.

**NORMALISING.**  
**ANNEALING.**  
**HARDENING.**  
**OIL QUENCHING**  
**and TEMPERING.**  
**CASE HARDENING.**

Telegrams:  
"QUENCHING,"  
COVENTRY.

**MECHANICAL TESTING. & CHEMICAL ANALYSIS**

## **SANDY LANE, COVENTRY.**



# HOYT BEARING METALS,

IN LARGEST USE FOR AERO ENGINES.

300-H.P.  
"GREEN"  
AERO  
ENGINE.

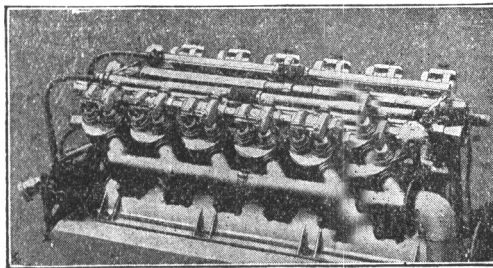

BEARINGS :  
HOYT  
METAL  
LINED.

**NUMBER ELEVEN—THE WORLD'S BEST.**

OUTLASTS ALL OTHERS.

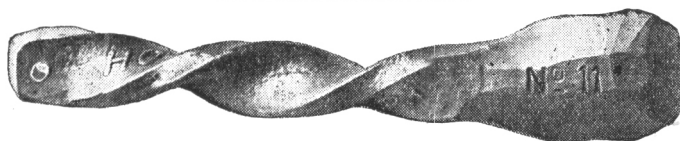

ABSOLUTELY THE HIGHEST QUALITY WHITE METAL MADE.  
SPECIMEN TWISTED AND HAMMERED COLD, SHOWING TOUGHNESS.  
COMPRESSION REQUIRED TO CRACK TEST SAMPLES: 20'55 TONS SQ. IN.

**THE HOYT METAL CO., LTD.,**

(WORKS : MILLWALL, E.)

189, HAMMERSMITH ROAD, LONDON, W.6.

# PETTERS LIMITED.

**AIRCRAFT CONSTRUCTORS  
TO THE ADMIRALTY.**

Orders can be accepted for  
**Complete Machines  
Propellers  
Parts.**

**WESTLAND AIRCRAFT WORKS**

(Branch of Petters Limited),

**YEOVIL, ENGLAND.**

Telegrams : "Aircraft-Yeovil."

Telephone : Yeovil 141.

The .  
**Sopwith Aviation Co.**  
Limited

CONTRACTORS TO H.M. GOVERNMENT.

OFFICE AND WORKS -  
**KINGSTON-ON-THAMES**

Telephone . KINGSTON 1988 (8 lines).  
Telegrams . SOPWITH, KINGSTON



Paris Office .  
21, RUE DU MONT THABOR.

# The Aëronautical Journal.

THE ORGAN OF THE ROYAL AÉRONAUTICAL SOCIETY.

## CONTENTS, DECEMBER, 1918.

For the opinions expressed in papers that are signed or initialled the authors alone are responsible. None of the papers or paragraphs must be taken as expressing the opinion of the Council of the Royal Aëronautical Society, unless such is definitely stated to be the case.

	PAGE
I. NOTICES ... ..	389
II. FIGHTING IN THE AIR, BY MAJOR COCHRANE PATRICK, D.S.O., R.A.F. ...	391
III. PROCEEDINGS FIRST MEETING, 54TH SESSION ... ..	414
IV. PROCEEDINGS FIFTH MEETING, 54TH SESSION ... ..	417
V. ABRIDGMENTS OF RECENT PATENT SPECIFICATIONS (AERONAUTICS) ... ..	423
VI. BIBLIOGRAPHY ... ..	426
VII. ABSTRACTS ... ..	427
VIII. REVIEWS... ..	430

All communications respecting Editorial Matters should be addressed to—

THE EDITOR, 7, Albemarle Street, W.1.

Telegrams: "DIDASKALOS, PICCY, LONDON."

TELEPHONE: 7373 GERRARD.

All communications respecting Advertisement Matters should be addressed to—

The Advertisement Manager, 63, Ludgate Hill, London, E.C. 4.

# THE ALUMINIUM CASTINGS CO. LD.

ESTABLISHED 1901.

SOUND CASTINGS.

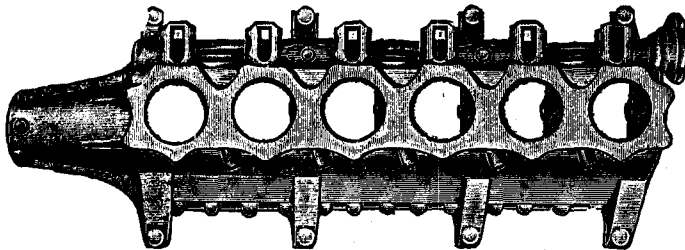

PROMPT DELIVERIES.

## Ingleston Foundry, GREENOCK, SCOTLAND.

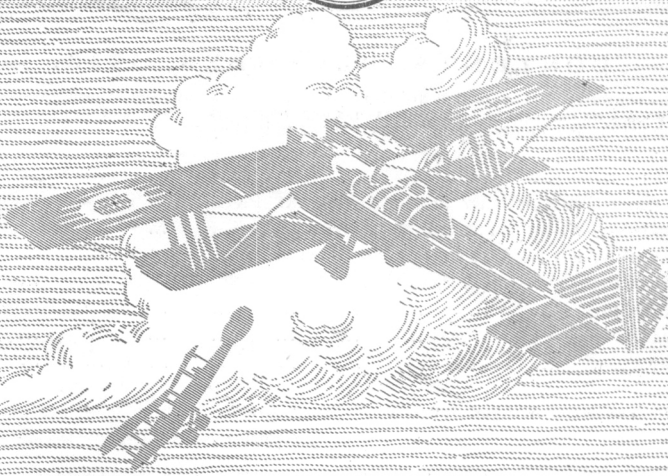

# B.L.I.C.

THE BRITISH LIGHTING & IGNITION CO. LTD.

MODERN WARFARE is the supreme test of all mechanism—whatever the circumstances, it must not fail. And under these strenuous conditions the "B.L.I.C." Magneto has fully demonstrated its unrivalled superiority. Built in a British factory by British workmen, it is the most reliable Magneto yet constructed—British or foreign.

THE BRITISH  
LIGHTING AND  
IGNITION  
CO., LTD.

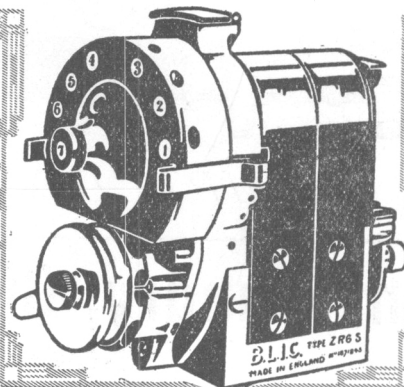

204, TOTTENHAM  
COURT ROAD,  
LONDON, W.  
Proprietors: VICKERS, LTD.