

Covariable changes of septal spacing and conch shape during early ontogeny: a common characteristic between Perisphinctina and Ancyloceratina (Ammonoidea, Cephalopoda)

Yutaro Nishino,¹ Keisuke Komazaki,¹ Masaki Arai,¹ Ai Hattori,² Yuji Uoya,³ Takahiro Iida,¹ and Ryoji Wani^{4*} 

¹Graduate School of Environment and Information Sciences, Yokohama National University, Yokohama 240-8501, Japan <macnannan16@gmail.com>, <dinosaur5634114@gmail.com>, <raim281708@gmail.com>, <iidtkhr0706@icloud.com>

²College of Urban Science, Yokohama National University, Yokohama 240-8501, Japan <hacchori0513@gmail.com>

³College of Engineering Science, Yokohama National University, Yokohama 240-8501, Japan <nightmare.to.remember38@gmail.com>

⁴Faculty of Environment and Information Sciences, Yokohama National University, Yokohama 240-8501, Japan <wani@ynu.ac.jp>

Non-technical Summary.—Ammonoids are an extinct group of cephalopods that lived from the Devonian until the end of the Cretaceous periods. In the Jurassic and Cretaceous periods, there were four suborders, Ancyloceratina, Perisphinctina, Lytoceratina, and Phylloceratina. Ancyloceratina formed a conch with detached whorls (open coiling) or non-planispiral coiling. The origin of Ancyloceratina remains unclear. In this study, we analyzed conch morphology in detail using specimens collected from southern India, Madagascar, and Japan. As a result, we found a common trend in conch morphology in early ontogeny of Ancyloceratina and Perisphinctina. We think that the similarity of conch morphology suggests a closer relationship between them, relative to Lytoceratina or Phylloceratina. Our findings are meaningful to consider the phylogenetic relationship and evolution of Jurassic–Cretaceous ammonoids.

Abstract.—We analyzed the ontogenetic trajectories of conch morphology and septal spacing between successive chambers in Cretaceous ammonoids (suborders Perisphinctina and Ancyloceratina) collected from southern India, Madagascar, and Japan. All examined species, except for the family Collignoniceratidae, exhibited similar characteristics during early ontogeny. The common ontogenetic trajectories of septal spacing show a cycle comprising an increase and a subsequent decrease in septal spacing during early ontogeny. The conch diameters at the end of the cycle were estimated to be 1–4 mm. The conch shape (aperture height and whorl expansion rate) covariably changed at this conch diameter. Such covariable changes are commonly recognized in the suborders Perisphinctina and Ancyloceratina. The similarity in the ontogenetic trajectories of conch morphology implies a closer phylogenetic relationship between these suborders compared to Lytoceratina or Phylloceratina.

Introduction

Ectocochleate cephalopods (ammonoids and nautiloids) contain septate shells that serve as buoyancy devices (Jacobs and Chamberlain, 1996; Hoffmann et al., 2015, 2018; Naglik et al., 2015; Tajika et al., 2015; Lemanis et al., 2016). They retain records of growth in their shells, which consist of a septate phragmocone and a body chamber. Analyses of the ontogenetic trajectories of conch morphology and septal spacing enable us to recognize the chamber formation system throughout the animal's ontogeny (De Baets et al., 2015b; Klug and Hoffmann, 2015). Furthermore, recognizing the similarities in ontogenetic trajectories of conch morphology and septal spacing between different ammonoid taxa may indicate close phylogenetic relationship between these taxa (e.g., Shigeta et al., 2001). Arai and Wani (2012) examined 10 Late Cretaceous species within Phylloceratina, Lytoceratina, Perisphinctina, and Ancyloceratina from

Hokkaido, Japan (see Bessenova and Mikhailova, 1991, and Yacobucci, 2015, for the definition of the higher taxonomy). Among these ammonoids, Ancyloceratina is regarded as a polyphyletic group (Wiedmann, 1969; Wright et al., 1996; Lehmann, 2015; Peterman and Barton, 2019; Hoffmann et al., 2021; Landman et al., 2021). Their higher-level systematics also remains problematic (Lehmann, 2015; Yacobucci, 2015; Hoffmann et al., 2021). Detailed morphological examination and increase in morphological data of Ancyloceratina would offer interesting perspectives on ammonoid heteromorphy and allow assessment of the polyphyletic nature of this group (Landman et al., 2021).

Although the number of examined specimens and species in Arai and Wani (2012) was not significant, their analyses suggested that the ontogenetic trajectories of septal spacing showed slight variation at the species level and were uniform until the superfamily level, except for Phylloceratina. However, the examined specimens occurred only in Hokkaido, Japan, so such similarity in septal spacing at the superfamily level could have been indicated regionally. Takai et al. (2022) further investigated the Late Cretaceous desmoceratids of Hokkaido and

*Corresponding author

Madagascar, revealing a common septal spacing pattern during the post-embryonic stage, regardless of the region or geological stage during the Cretaceous, at least within the subfamily Desmoceratinae. Here, we examined the ontogenetic trajectories of conch morphology and septal spacing in previously unanalyzed Cretaceous ammonoid species. We aimed to (1) uncover the ontogenetic trajectories of septal spacing and conch morphology of the suborders Perisphinctina and Ancyloceratina, (2) examine whether these conch morphologies covariably change, (3) elucidate whether the ontogenetic trajectories of septal spacing and conch morphology share similar characteristics between the suborders Perisphinctina and Ancyloceratina, and (4) discuss the paleoecological implications.

Materials

In this study, we examined 133 specimens belonging to nine species of the suborder Perisphinctina and two species of the suborder Ancyloceratina (Figs. 1, 2; Table 1; Supplementary Data 1). Irregular shell growth (e.g., injuries) and epifaunal attachments were not visible in any of the examined specimens (Figs. 1, 2).

The examined specimens of *Puzosia* sp. (Puzosinae, Desmoceratidae, Desmoceratoidea, Perisphinctina; six specimens), *Menabonites anapadensis* (Kossmat, 1898) (Pachydiscidae, Desmoceratoidea, Perisphinctina; four specimens), *Nowakites* sp. (Pachydiscidae, Desmoceratoidea, Perisphinctina; three specimens), *Pseudoschloenbachia* sp. (Muniericeratidae, Desmoceratoidea, Perisphinctina; two specimens), *Placenticerus tamulicum* (Blanford, 1862) (Placenticeratidae, Hoplitoida, Perisphinctina; seven specimens) were collected from the Ariyalur area, southern India. Lower to Upper Cretaceous deposits, ranging from the Albian to the Maastrichtian, are exposed in the Ariyalur area in the Cauvery Basin of the Tamil Nadu sector of southern India (Sundaram et al., 2001). These strata are divided into the Uttatur, Trichinopoly, and Ariyalur groups, in ascending order. The Trichinopoly Group is subdivided into the Kulakkalnattam and Anaipadi formations, and the Ariyalur Group is subdivided into the Sillakkudi, Kallakurichchi, Kallamedu, and Niniyur formations (Sundaram et al., 2001). The fossil locations of *Puzosia* sp., *Menabonites anapadensis*, *Nowakites* sp., and *Placenticerus tamulicum* were assigned to the lower part of the Anaipadi Formation. The co-occurring ammonoid assemblages and previously reported biostratigraphic correlations with oysters (Ayyasami, 2006) suggest that the studied horizon in the lower part of the Anaipadi Formation is middle Turonian in age. The fossil locality of *Pseudoschloenbachia* sp. was assigned to the Sillakkudi Formation. This horizon is thought to be Campanian in age (Sundaram et al., 2001).

We also examined 34 specimens of *Cleoniceras* sp. (Cleoniceratinae, Desmoceratoidea, Perisphinctina), three specimens of *Beudanticeras* sp. (Beudanticeratinae, Desmoceratidae, Desmoceratoidea, Perisphinctina), and five specimens of *Douvilleicerus* sp. (Douvilleiceratinae, Douvilleiceratidae, Douvilleiceratoidea, Ancyloceratina) collected from the Mahajanga area, Madagascar (Collignon, 1949, 1963). The limestone block in the Mahajanga area is rich in well-preserved mollusk

fossils. The geological age of these specimens is thought to be early Albian (Collignon, 1949, 1963; Hoffmann et al., 2019).

Fifteen specimens of Jurassic *Perisphinctes* sp. (Perisphinctinae, Perisphinctidae, Perisphinctoidea, Perisphinctina) were analyzed for comparison with Cretaceous ammonoids. These specimens were collected in the Late Jurassic (Oxfordian) of the Morondava Basin (Maroroka section, Ilovo Valley) of southwestern Madagascar. In this area, the Upper Jurassic consists of interfingering shallow-marine and continental deposits, where the bathymetry did not exceed 50 m (Besairie, 1972). During this period, the shallow marine basin was located at approximately 40°S (Besse and Courtillot, 1988).

Thirty specimens of *Subprionocyclus minimus* (Hayasaka and Fukada, 1951) (Collignoniceratinae, Collignoniceratidae, Acanthoceratoidea, Perisphinctina) were collected from the Manji area in Hokkaido, Japan. The geological age of these specimens is thought to be late Turonian (Tanabe et al., 1978; Harada and Tanabe, 2005).

Ten specimens of *Yezoites puerculus* (Jimbo, 1894), (Otoscapitinae, Scaphitidae, Scaphitoidea, Ancyloceratina) were collected from the Obira area, Hokkaido, Japan. We also used specimens examined by Yahada and Wani (2013), which were collected from the Kotanbetsu and Oyubari areas (seven specimens from each area) in Hokkaido. The stratigraphic horizons of all the scaphitid specimens used in this study were the middle Turonian (Tanabe, 1977, 2022; Yahada and Wani, 2013). The examined scaphitids, *Yezoites puerculus* and *Yezoites planus* Yabe, 1910, represent sexual dimorphs of a single species (Tanabe, 1977, 2022). All the specimens examined in this study were macroconchs (Callomon, 1955) of this species.

Repository and institutional abbreviation.—Figured and other specimens examined in this study are deposited in the Mikasa City Museum (MCM), Hokkaido, Japan.

Methods

Each specimen was polished along its median plane (plane of symmetry) using a silicon carbide powder. The septal spacing between successive septa was defined as the rotational angle between two consecutive septa (i.e., N and N–1 septal numbers) at the positions where the septum met the siphuncle (Fig. 3.1) and was measured using a digital optical microscope (Keyence VHX-900; magnification $\times 25$ –175; error $< 0.01^\circ$). The center of rotation was defined as the center of the initial chamber's maximum diameter through the base of the caecum (Fig. 3.1). The measured septal spacings are shown as graphs of the septal spacing between two successive septa (N and N–1) against the phragmocone diameter through ontogeny (Figs. 4–6). This is because the septal numbers could not be accurately determined in most specimens owing to partial dissolution, especially of the earliest whorl.

To measure conch shape, we measured aperture height (Klug et al., 2015; Fig. 3.2) on the median plane, every 180° in *Cleoniceras* sp., *Perisphinctes* sp., and *Yezoites puerculus* or 45° in the other examined species (regarding differences in the accuracy of the resultant growth trajectories, refer to Tajika and Klug, 2020). Based on these measurements, scatter

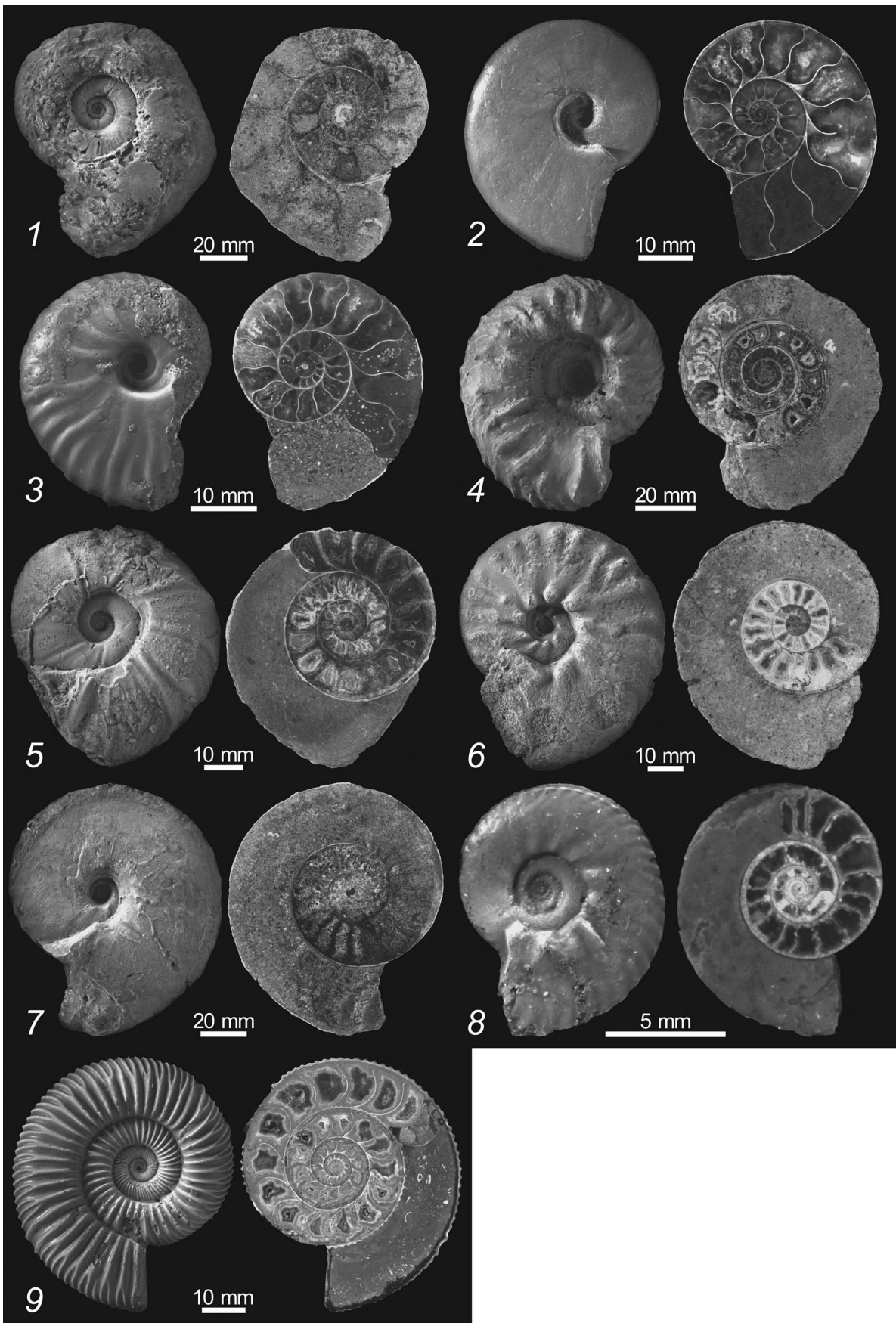

←
Figure 1. Examined species of the suborder Perisphinctina. (1) *Puzosia* sp., MCM-W2026, Turonian, Ariyalur area; (2) *Beudanticeras* sp., MCM-W2034, Albian, Mahajanga area; (3) *Cleoniceras* sp., MCM-W2066, Albian, Mahajanga area; (4) *Menabonites anapadensis*, MCM-W2069, Turonian, Ariyalur area; (5) *Nowakites* sp., MCM-W2073, Turonian, Ariyalur area; (6) *Pseudoschloenbachia* sp., MCM-W2077, Campanian, Ariyalur area; (7) *Placenticeras tamulicum*, MCM-W2079, Turonian, Ariyalur area; (8) *Subprionocyclus minimus*, MCM-W2103, Turonian, Manji area; (9) *Perisphinctes* sp., MCM-W2115, Late Jurassic, Morondava area.

diagrams of the aperture height and conch diameter were constructed (Figs. 4–6). We discerned the critical point(s) at which the slopes of the regression lines (calculated by the reduced major axis) changed (statistically significant, $p < 0.05$; Kermack and Haldane, 1950; Hayami and Matsukuma, 1970).

The whorl expansion rate (WER), which is one of the major parameters of ammonoid conchs, was measured on the median plane, as a representative parameter of conch shape (Klug et al., 2015). The WER was measured on the median plane in each specimen (the measurement intervals were the same as those of the aperture heights), and the ontogenetic trajectories of each WER were recorded (Figs. 4–6).

Ammonitella diameters were measured using an optical microscope with a digital measurement tool (Keyence VHX-900; magnification $\times 25$ –175; error < 0.01 mm). In this study, the ammonitella diameter was defined as the maximum diameter of the ammonitella from the primary constriction (Landman et al., 1996; De Baets et al., 2015a).

Results

Septal spacing of Perisphinctina.—The ontogenetic trajectories of the septal spacing of Perisphinctina are shown in Figures 4–6 and Supplementary Data 1. These can be categorized into two trends. The first ontogenetic trend was observed in most of the examined Perisphinctina species except for *Subprionocyclus minimus*. In the first ontogenetic trend, there was a cycle until 0.7–1.6 mm in phragmocone diameter without body chamber length (Figs. 4–6; Table 1), the cycle comprised an increase and subsequent decrease in septal spacing. Thereafter, the ontogenetic trajectories of septal spacing almost flattened out in *Puzosia* sp., *Menabonites anapadensis*, *Nowakites* sp., and Jurassic *Perisphinctes* sp., or showed a slightly decreasing trend with a constant slope in *Beudanticeras* sp., *Cleoniceras* sp., *Pseudoschloenbachia* sp., and *Placenticeras tamulicum* (Figs. 4–6).

The second trend was observed in *Subprionocyclus minimus*. Their ontogenetic trajectories showed a zigzag pattern that continued until ~ 10 mm in phragmocone diameter, with amplitudes decreasing with growth (Fig. 5.10).

Aperture height of Perisphinctina.—Scatter diagrams of the aperture height and conch diameter are shown in Figures 4–6. We recognized the critical point(s) of regression lines on the scatter diagrams, at which the slopes of the regression lines (reduced major axes) significantly differed ($p < 0.05$). Most species have two critical points at 0.5–0.8 mm and 1.3–3.2 mm conch diameter (Figs. 4–6; Table 1). We recognized a single critical point in *Beudanticeras* sp. and *Pseudoschloenbachia* sp. and no critical point in *Puzosia* sp., possibly because of poor preservation and the limited number of examined specimens. In such species, we discriminated critical points as either the first or the second based on the shifting trend of the slopes of the regression lines (from steeper to gentler or gentler to steeper slopes; Table 1).

WER of Perisphinctina.—Ontogenetic trajectories of the WER followed a similar trend within the suborder Perisphinctina (Figs. 4–6). WER values first increased until 0.5–1.6 mm conch diameter, then decreased until 1.3–5.8 mm conch diameter, and subsequently increased. We recognized only a single turning point in *Puzosia* sp., *Beudanticeras* sp., and *Pseudoschloenbachia* sp., possibly because of poor preservation of the earliest whorl and the limited number of examined specimens. In such species, we discriminated critical points as either the first or the second, based on the shifting trend of ontogenetic trajectories (from increasing to decreasing or decreasing to increasing trends; Table 1).

Septal spacing of Ancyloceratina.—Ontogenetic trajectories of the septal spacing in Ancyloceratina are shown in Figure 6 and Supplementary Data 1. They exhibited a cycle until

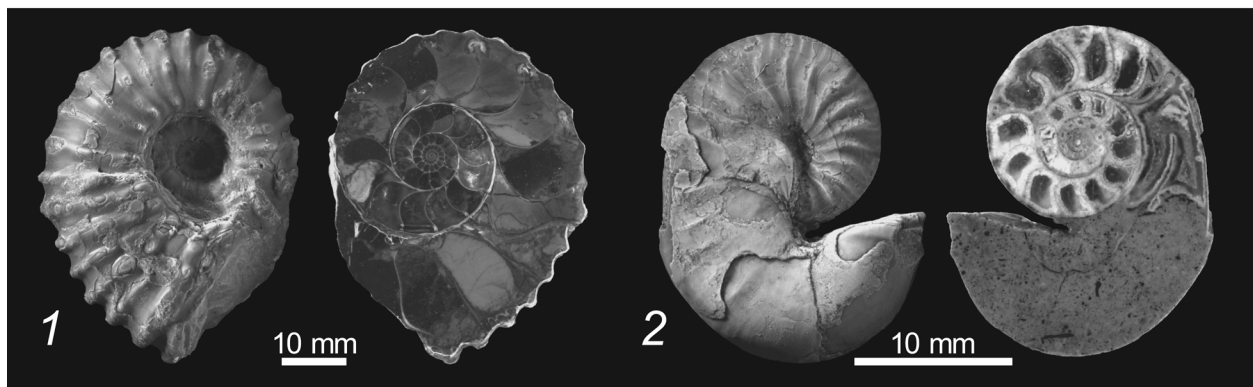

Figure 2. Examined species of the suborder Ancyloceratina. (1) *Douvilleiceras* sp., MCM-W2134, Albian, Mahajanga area; (2) *Yezoites puerculus*, MCM-W1307, Turonian, Kotanbetsu area.

Table 1. Summary of conch morphological analyses, including the following taxa not mentioned elsewhere in the text: *Damesites damesi intermedius* Matsumoto, 1954; *Tragodesmocerooides subcostatus* Matsumoto, 1942; *Desmoceras latidorsatum forma complanata* Jacob, 1907; *Desmoceras latidorsatum forma media* Jacob, 1907; and *Desmoceras latidorsatum forma inflata* Breisroffer, 1933.

| Species | Ammonitella diameter (mm) | Phragmocone diameter at the end of septal spacing cycle (mm) | Reconstructed shell diameter at the end of septal spacing cycle (mm) | Aperure height vs. shell diameter | | WER | |
|---|---------------------------|--|--|---|---|---|---|
| | | | | 1st critical point (steeper slope to gentler slope) | 2nd critical point (gentler slope to steeper slope) | 1st critical point (increasing trend to decreasing trend) | 2nd critical point (decreasing trend to increasing trend) |
| Perisphinctina | | | | | | | |
| Desmoceratoidea | | | | | | | |
| Desmoceratidae | | | | | | | |
| Puzosinae | | | | | | | |
| <i>Puzosia</i> sp. | 0.8 | 1.3 | 2.2 | | | | 1.6 |
| Beudanticeratinae | | | | | | | |
| <i>Beudanticeras</i> sp. | 0.7–0.9 | 1.0–1.3 | 1.8–2.3 | | 1.9 | | 1.6 |
| Desmoceratinae | | | | | | | |
| <i>Damesites damesi intermedius</i> * | 0.7–1.0 | 0.6–1.3 | 1.3–2.1 | 0.6 | 1.5 | 0.6–0.9 | 1.3–1.9 |
| <i>Tragodesmocerooides subcostatus</i> * | 0.8–0.9 | 0.9–1.4 | 1.7–2.3 | | | | |
| <i>Desmoceras latidorsatum forma complanata</i> * | 0.9–1.1 | 0.8–1.3 | 1.4–2.3 | 0.8 | 2.4 | 0.8–0.9 | 1.6–2.7 |
| <i>Desmoceras latidorsatum forma media</i> * | 0.7–0.8 | 0.7–1.1 | 1.3–2.1 | 0.5 | 1.7 | 0.6–0.8 | 1.5–2.4 |
| <i>Desmoceras latidorsatum forma inflata</i> * | 0.6–0.7 | 0.8–1.0 | 1.4–1.6 | 0.5 | 1.8 | 0.4–0.5 | 1.3–2.0 |
| Cleoniceratinae | | | | | | | |
| <i>Cleoniceras</i> sp. | 0.9–1.1 | 1.1–1.5 | 1.9–2.7 | 0.7 | 2.5 | 0.8–0.9 | 1.8–2.2 |
| Pachydiscidae | | | | | | | |
| <i>Menabonites anapadensis</i> | 0.7 | 1.0 | 1.5 | 0.6 | 1.5 | 0.6–0.7 | 1.7–2.0 |
| <i>Nowakites</i> sp. | 0.7–0.9 | 1.0 | 1.6 | 0.6 | 1.6 | 0.5–0.7 | 1.5 |
| Muniericeratinae | | | | | | | |
| <i>Pseudoschloenbachia</i> sp. | 0.9 | 1.2 | 2.0 | | 2.1 | | 1.6 |
| Hoplitoidea | | | | | | | |
| Placenticeratinae | | | | | | | |
| <i>Placenticeras tamulicum</i> | 0.9–1.6 | 2.1 | 4.1 | | 2.7 | 0.7–1.1 | 2.4–3.6 |
| Acanthoceratoidea | | | | | | | |
| Collignoniceratinae | | | | | | | |
| <i>Subprionocyclus minimus</i> | 0.7–0.9 | | | 0.6 | 1.3 | 0.5–0.8 | 1.9–3.1 |
| Perisphinctoidea | | | | | | | |
| Perisphinctidae | | | | | | | |
| Perisphinctinae | | | | | | | |
| <i>Perisphinctes</i> sp. | 0.7–0.9 | 0.8–1.6 | 1.0–2.5 | 0.6 | 3.2 | 0.7–2.0 | 1.3–5.2 |
| Ancyloceratina | | | | | | | |
| Douvilleiceratoidea | | | | | | | |
| Douvilleiceratinae | | | | | | | |
| <i>Douvilleiceras</i> sp. | 0.9–1.0 | 1.3 | 2.3 | 1.0 | 2.2 | 1.0–1.1 | 2.0–2.4 |
| Scaphitoidea | | | | | | | |
| Scaphitidae | | | | | | | |
| Otoscapitinae | | | | | | | |
| <i>Yezoites puerculus</i> | 0.7–1.0 | 0.9–1.2 | 1.4–2.0 | 0.8 | 2.1–2.8 | 0.8–1.2 | 1.5–3.3 |
| Scaphitinae | | | | | | | |
| <i>Hoploscapites comprimis</i> (J-273) ** | 0.7 | 0.6 | 1.1 | 0.8 | 1.2 | | 0.9 |

* data from Takai et al. (2022); ** data from Linzmeier et al. (2018)

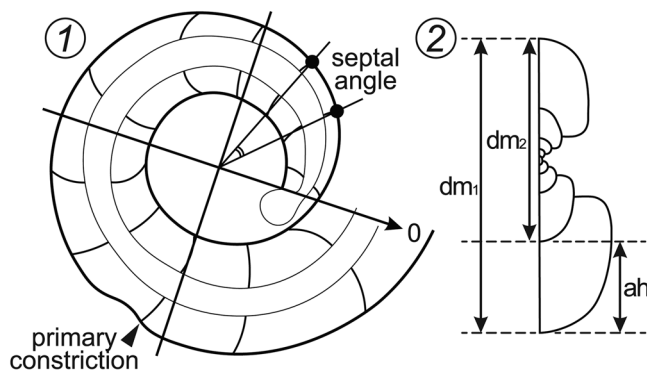

Figure 3. Measurements of conch morphology. (1) Septal spacing, the center of rotational angle, and the base of measurement through prosepium (0); (2) measurements of conch shape: ah, aperture height; whorl expansion rate (WER) = $(dm_1/dm_2)^2$.

0.6–1.3 mm in phragmocone diameter without body chamber length (Fig. 6; Table 1), the cycle comprised an increase and subsequent decrease in septal spacing. Thereafter, the ontogenetic trajectories of septal spacing almost flattened in both *Douvilleiceras* sp. and *Yezoites puerculus* (Fig. 6).

Aperture height of Ancyloceratina.—The scatter diagrams of the aperture height and conch diameter are shown in Figure 6. We recognized the critical points of regression lines on the scatter diagrams, where the slopes of the regression lines (reduced major axes) significantly differed ($p < 0.05$). All examined species exhibited two critical points at 0.8–1.0 mm and 2.1–2.8 mm conch diameter (Fig. 6; Table 1).

WER of Ancyloceratina.—Ontogenetic trajectories of the WER followed a similar trend within the suborder Ancyloceratina (Fig. 6). WER values first increased until 0.8–1.2 mm conch diameter, then decreased until 1.5–3.3 mm conch diameter, and subsequently increased.

Discussion

Covariations between septal spacing and conch shape.—Our results showed that the ontogenetic trajectory patterns of conch shape (septal spacing, WER, and aperture height) during early ontogeny (< 5 mm in conch diameter) shared similar characteristics in most examined species of Perisphinctina (except for Collignoniceratidae) and Ancyloceratina (Figs. 4–6). We further investigated whether conch morphological alterations were covariably conformable within the examined conch shapes.

Because the phragmocone diameters measured in this study did not include the body chamber, conch diameters, including body chambers, should be estimated to recognize actual conch size at the time of habitat. However, it is difficult to accurately determine the precise body chamber length at a particular ontogenetic stage, except for the hatching (i.e., ammonitella) and mature stages. Arai and Wani (2012) estimated conch diameters by postulating that the body chamber length during the early post-embryonic stage was approximated to an ammonitella angle between the nepionic constriction and prosepium. We adopted this relatively accurate method to estimate conch

diameters, including body chamber length (Kawakami et al., 2022; Takai et al., 2022; Kawakami and Wani, 2023).

By comparing measured and estimated conch diameters, we recognized two ontogenetic stages at which the plural conch shape covariably changed (Figs. 4–6; Table 1). The first ontogenetic stage was approximately 0.6–1.1 mm in conch diameter. These values indicate that (1) the conch diameters at which the slope of the regression line between the aperture height and conch diameter shifted from a steeper into a gentler trend, and (2) the WER trend changed from an increasing to a decreasing trend (Figs. 4–6; Table 1). The conch diameters at this ontogenetic stage approximate the ammonitella diameters of each species (Table 1). This correspondence suggests that this ontogenetic stage, with the covariation of conch shape, was related to hatching. Before hatching, ammonoids are thought to have no septa (except for the prosepium) (Tanabe et al., 1993; Landman et al., 1996; De Baets et al., 2015a). Therefore, the ontogenetic trajectory trends of the septal spacing were unaffected at this ontogenetic stage.

The second ontogenetic stage was at about 1.4–3.3 mm in conch diameter (Figs. 4–6; Table 1). These values indicated that (1) the ontogenetic trajectories of septal spacing changed from a cycle comprising an increase and subsequent decrease into an almost flat trend; (2) the conch diameters at which the slope of the regression line between aperture height and conch diameter transitioned from a gentler to a steeper trend; and (3) the WER trend changed from a decreasing to an increasing trend (Figs. 4–6; Table 1). The shift in ontogenetic trajectory pattern of septal spacing is commonly known to be marked by changes in several other conch shape features (Bucher et al., 1996; Arai and Wani, 2012; Kawakami et al., 2022; Takai et al., 2022; Kawakami and Wani, 2023). Therefore, our observations are consistent with these previous observations.

We re-evaluated the morphological data of Desmoceratinae examined by Takai et al. (2022) (152 specimens of three species; Desmoceratidae, Desmoceratoidea, Perisphinctina). The subfamily Desmoceratinae also showed covariation in conch morphology and septal spacing during early ontogeny (Table 1). The characteristics of these covariations were similar to those of Perisphinctina and Ancyloceratina in the present study.

An exception was Collignoniceratidae (Fig. 5; Table 1). Collignoniceratidae lacked the septal spacing trend, such as a cycle comprising an increase and subsequent decrease, and thereafter an almost flat trend, which is common among most of the examined Perisphinctina and Ancyloceratina (Figs. 4–6; Arai and Wani, 2012).

Phylogenetic relationship.—Takai et al. (2022) reported that the ontogenetic trajectories of conch morphology and septal spacing are almost uniform in Desmoceratinae. Our results suggest that these characteristics of conch morphology and septal spacing are common not only in the subfamily Desmoceratinae (Takai et al., 2022) but also in most of the examined Perisphinctina (except for Collignoniceratidae). Because we examined specimens from various regions (Hokkaido, Madagascar, and southern India), the similarity in septal spacing in most of the examined Perisphinctina was probably independent of whether they were in the Northern or Southern Hemisphere during the Cretaceous.

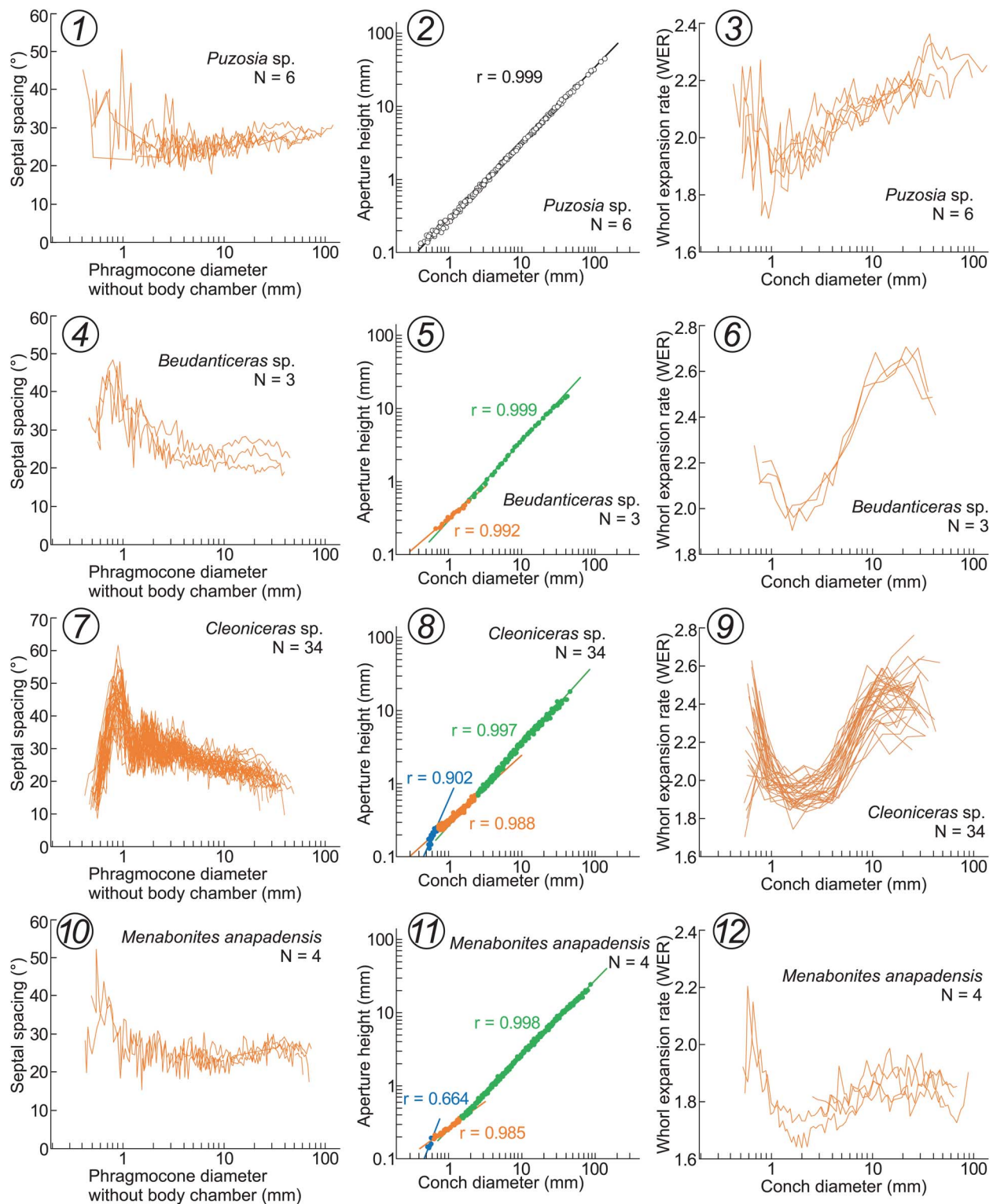

Figure 4. Graphs of conch morphology through ontogeny. (1) Septal spacing of *Puzosia* sp.; (2) aperture height vs. conch diameter of *Puzosia* sp.; (3) WER vs. conch diameter of *Puzosia* sp.; (4) septal spacing of *Beudanticeras* sp.; (5) aperture height vs. conch diameter of *Beudanticeras* sp.; (6) WER vs. conch diameter of *Beudanticeras* sp.; (7) septal spacing of *Cleoniceras* sp.; (8) aperture height vs. conch diameter of *Cleoniceras* sp.; (9) WER vs. conch diameter of *Cleoniceras* sp.; (10) septal spacing of *Menabonites anapadensis*; (11) aperture height vs. conch diameter of *Menabonites anapadensis*; (12) WER vs. conch diameter of *Menabonites anapadensis*. Blue, red, and green line colors (5, 8, 11) indicate three phases that can be divided by critical points. The r values indicate the coefficients of correlation of the reduced major axis of each stage.

Furthermore, because the Jurassic *Perisphinctes* exhibits similar characteristics (Fig. 6.1–6.3; Table 1) implies that the common trajectory patterns of conch morphology and septal

spacing can be traced back at least to the Late Jurassic. If this estimation holds true, the morphological characteristics of the early ontogeny of the suborder Perisphinctina may have been

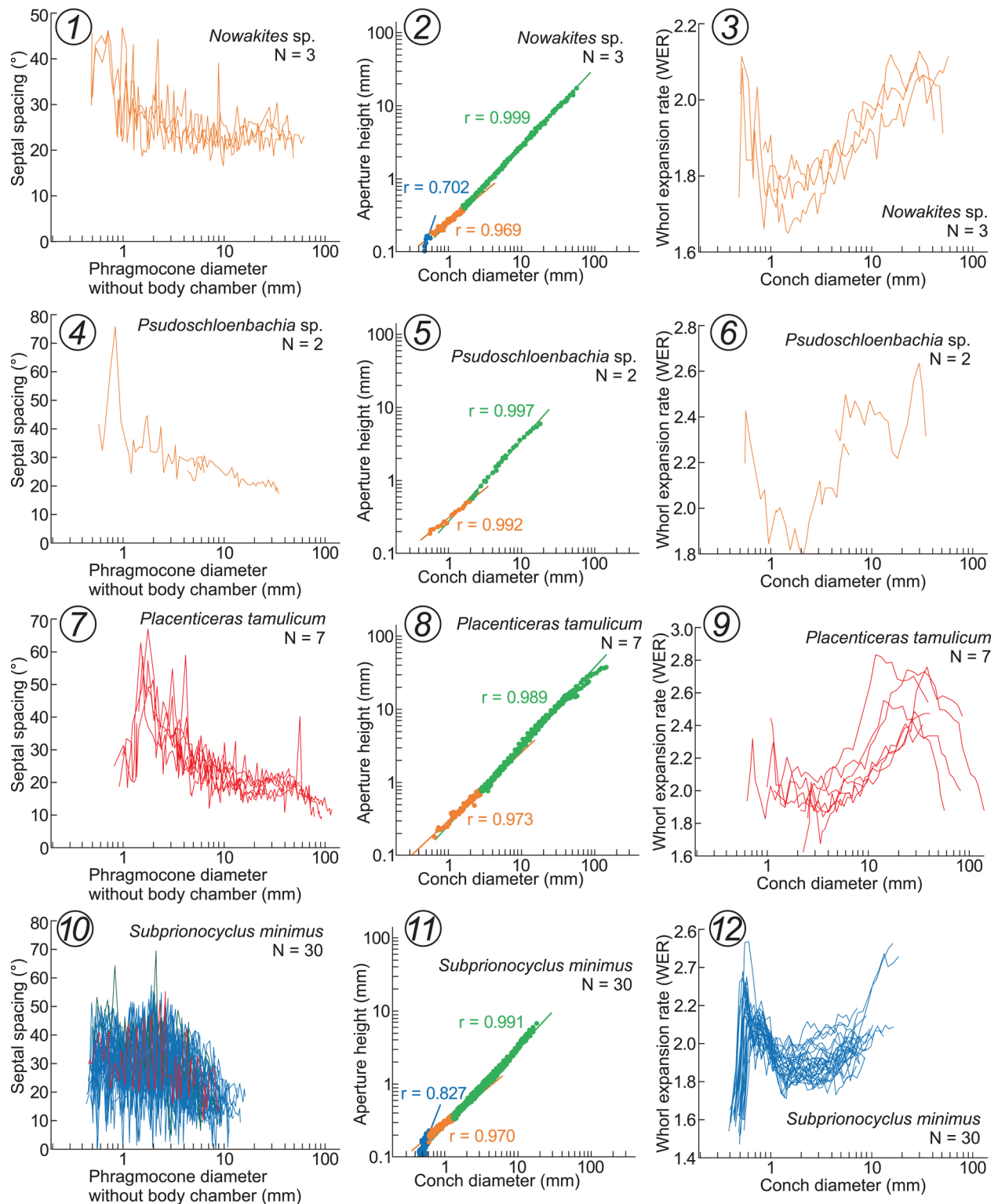

Figure 5. Graphs of conch morphology through ontogeny. (1) Septal spacing of *Nowakites* sp.; (2) aperture height vs. conch diameter of *Nowakites* sp.; (3) WER vs. conch diameter of *Nowakites* sp.; (4) septal spacing of *Pseudoschloenbachia* sp.; (5) aperture height vs. conch diameter of *Pseudoschloenbachia* sp.; (6) WER vs. conch diameter of *Pseudoschloenbachia* sp.; (7) septal spacing of *Placenticerias tamulicum*; (8) aperture height vs. conch diameter of *Placenticerias tamulicum*; (9) WER vs. conch diameter of *Placenticerias tamulicum*; (10) septal spacing of *Subprionocyclus minimus* (ontogenetic trajectory of a single specimen is shown in red color, to clearly show the ontogenetic trend of a single specimen, and the others are in green color); (11) aperture height vs. conch diameter of *Subprionocyclus minimus*; (12) WER vs. conch diameter of *Subprionocyclus minimus*. Blue, red, and green line colors (2, 5, 8, 11) indicate three phases that can be divided by critical points. The r values indicate the coefficients of correlation of the reduced major axis of each stage.

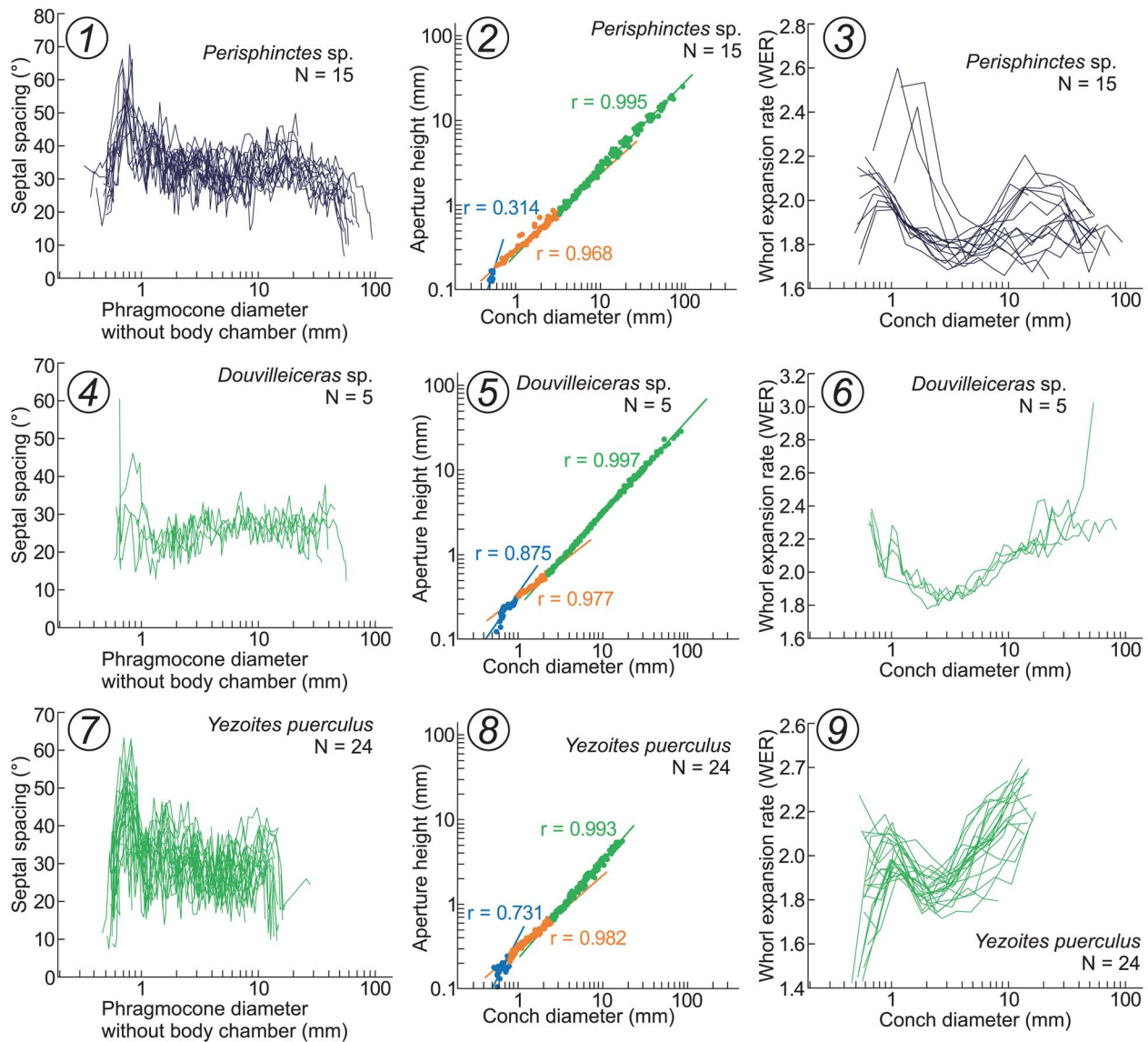

Figure 6. Graphs of conch morphology through ontogeny. (1) septal spacing of *Perisphinctes* sp.; (2) aperture height vs. conch diameter of *Perisphinctes* sp.; (3) WER vs. conch diameter of *Perisphinctes* sp.; (4) septal spacing of *Douvilleiceras* sp.; (5) aperture height vs. conch diameter of *Douvilleiceras* sp.; (6) WER vs. conch diameter of *Douvilleiceras* sp.; (7) septal spacing of *Yezoites puerculus*; (8) aperture height vs. conch diameter of *Yezoites puerculus*; (9) WER vs. conch diameter of *Yezoites puerculus*. Blue, red, and green line colors (2, 5, 8) indicate three phases that can be divided by critical points. The r values indicate the coefficients of correlation of the reduced major axis of each stage.

stable for over 90 My (from the Late Jurassic until the end of the Cretaceous). Although we did not examine all Perisphinctina species, considering current data (Arai and Wani, 2012; Iwasaki et al., 2020; Kawakami et al., 2022; Takai et al., 2022; Kawakami and Wani, 2023; this study), we hypothesize that the ontogenetic trajectories of conch morphology and septal spacing are phylogenetically dependent on the suborder Perisphinctina. In addition, the ontogenetic trajectories of septal spacing and conch morphology during early ontogeny contrast with those of Phylloceratina (Fig. 7.1; Arai and Wani, 2012; Iwasaki et al., 2020) and Lytoceratina (Fig. 7.2; Arai and Wani, 2012; Kawakami et al., 2022; Kawakami and Wani, 2023).

Bucher et al. (1996) reported an abrupt increase in septal spacing, followed by an equally sharp decrease at the end of the neanic stage in Middle Jurassic *Quenstedtoceras*

(Cardioceratidae, Stephanoceratoidea, Perisphinctina) and Late Cretaceous *Clioscaphtes* (Scaphitidae, Scaphitoidea, Ancyloceratina). These observations appear to be consistent with our results. However, this pattern is not as well developed in the Middle Jurassic *Sphaeroceras* (Sphaeroceratidae, Stephanoceratoidea, Perisphinctina) (Mignot, 1993; Bucher et al., 1996). Some specimens or species examined in this study did not show a clearly common ontogenetic trajectory pattern of conch morphology (Figs. 4–6; Table 1). These discrepancies may indicate some degree of variation within a species or at a higher taxonomic rank (at the subfamily or family level).

The most prominent discrepancy in the suborder Perisphinctina was seen in Collignoniceratidae (Fig. 5.10–5.12; Table 1; Arai and Wani, 2012). The Collignoniceratidae exhibited a unique zigzag ontogenetic trajectory pattern of septal

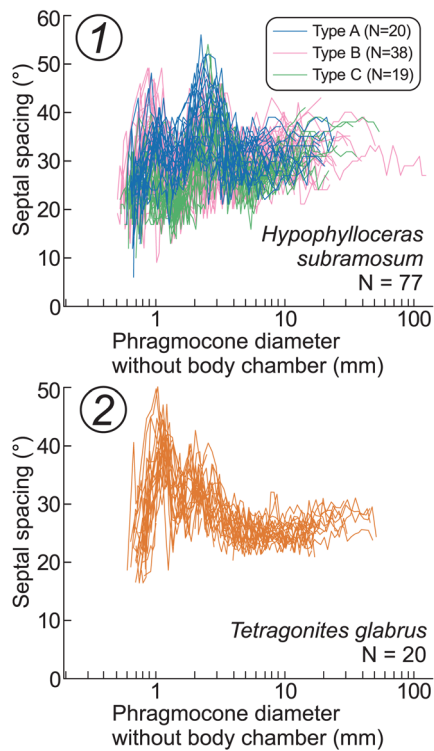

Figure 7. Graphs of septal spacing of Lytoceratina and Phylloceratina. (1) *Hypophylloceras subramosum* (Shimizu, 1934) (Phylloceratina). Data from Iwasaki et al. (2020). There are two cycles in early ontogeny, each comprising an increase and subsequent decrease in septal spacing. Note larger variations even within a single species, which can be classified into three types. (2) *Tetragonites glabrus* (Jimbo, 1894) (Lytoceratina). Data from Kawakami and Wani (2023). Two cycles, each comprising an increase and subsequent decrease in septal spacing, can be observed in early ontogeny.

spacing (Fig. 5.10). Arai and Wani (2012) demonstrated that the ontogenetic trajectories of Collignoniceratinae and Texanitinae (*Haboroceras* and *Protexanites*) showed a similarly zigzag pattern. Therefore, the zigzag patterns of septal spacing through ontogeny seem to be a common feature, at least in the subfamilies Collignoniceratinae and Texanitinae. Although we did not examine other subfamilies (Barroisiceratinae and Peroniceratinae) in the family Collignoniceratidae, this ontogenetic trajectory pattern of septal spacing may be a synapomorphy of the family Collignoniceratidae. Nonetheless, this pattern might even be a common feature of the superfamily Acanthoceratoidea, although no currently available data support this possibility.

If our hypothesis that the ontogenetic trajectories of septal spacing and conch morphology during early ontogeny are phylogenetically dependent holds true, the similarity between the suborders Perisphinctina and Ancyloceratina implies a closer phylogenetic relationship compared to Lytoceratina or Phylloceratina. In Jurassic–Cretaceous ammonoids, large-scale evolutionary connections remain unclear (Yacobucci, 2015). The origin of Ancyloceratina has been hypothesized to be Lytoceratina (Arkell et al., 1957; Wiedmann, 1966), Spiroceratoidea (Wright et al., 1996), or Perisphinctina (Donovan et al., 1981; Bessenova and Mikhailova, 1991; Page, 1996; Mikhailova and Baraboshkin, 2009; Yacobucci, 2015). The morphological similarity in early ontogeny of Perisphinctina and Ancyloceratina revealed in this study supports either Spiroceratoidea (in

Ammonitina) or Perisphinctina as the origin of Ancyloceratina. However, there are currently no available data on covariable changes in conch morphology during early ontogeny in Ancyloceratina (except for Douvilleiceratoidea and Scaphitoidea). This is because obtaining a tiny and fragile conch from the early ontogeny of a three-dimensionally coiled conch is technically challenging. The various types of three-dimensional coiling possibly influenced conch morphology during early ontogeny to some unknown degree.

Another explanation for the similarity between the suborders Perisphinctina and Ancyloceratina is convergent evolution. However, there are currently no data to positively support this possibility. Because most of the examined Perisphinctina (except for Collignoniceratidae) and Ancyloceratina show a similar trend, we consider that it is more reasonable to assume that the similarity between these suborders indicates their closer phylogenetic relationship. This should be tested in future studies, with shell morphological data of more abundant Jurassic and Cretaceous ammonoids.

Paleoecological implications.—In the most-examined species of Perisphinctina and Ancyloceratina, we identified two growth timings at which the conch shape covariablely changed. The first covariable change could be related to hatching. With what is the change in the second covariable change associated? What kinds of paleoecological attributes can be reconstructed from the second covariable change?

Based on the morphological changes seen in ammonoid shells (changes in coiling, umbilical exposure, ornamentation, and septal angle), ammonoid growth is subdivided into four stages: embryonic, neanic, juvenile, and mature stages (Westermann, 1958; Bucher et al., 1996; Klug, 2001). Each stage generally has the following septal spacing patterns: (1) the embryonic ammonoid, termed the ammonitella (Druschits and Khiami, 1970), consists of a protoconch (initial chamber) and approximately one planispiral whorl initiating at the caecum and terminating at the primary constriction with only the prosepium (Tanabe et al., 1993; Landman et al., 1996); (2) the neanic stage generally has wide septal spacing (Landman, 1987; Bucher et al., 1996); (3) juvenile ammonoids have almost uniform septal spacing (Bucher et al., 1996); and (4) mature ammonoids initially display increased angles followed by a decrease over the last few septa (Callomon, 1963; Crick, 1978; Landman and Waage, 1993; Davis et al., 1996; Klug, 2004; Klug et al., 2007).

Most ammonoid hatchlings were thought to be planktic (Kulicki, 1974, 1979, 1996; Druschits et al., 1977; Tanabe et al., 1980, 2001, 2003; Landman, 1985; Tanabe and Ohtsuka, 1985; Shigeta, 1993; Landman et al., 1996; Westermann, 1996; Rouget and Neige, 2001; Mapes and Nützel, 2009; Tajika and Wani, 2011; De Baets et al., 2012, 2013, 2015a; Ritterbush et al., 2014; Lemanis et al., 2015). During the neanic stage, ammonoids could still be planktic, and at the end of the neanic stage, they could shift to another mode of life (Westermann, 1958; Zell et al., 1979; Landman, 1987, 1988; Checa and Sandoval, 1989; Shigeta, 1993; Bucher et al., 1996; Arai and Wani, 2012; De Baets et al., 2015a; Lukeneder, 2015; Kawakami et al., 2022; Takai et al., 2022; Kawakami and Wani, 2023). Such a shift in the mode of life was possibly gradual, and therefore, a strict cutoff point might be hard to define. A

direct indicator of the transition of ammonoid modes of life is the oxygen isotopic signature preserved in the shell material, if the necessary quality of fossil preservation is permitted (Moriya et al., 2003; Lécuyer and Bucher, 2006; Lukeneder et al., 2010; Moriya, 2015a, b; Sessa et al., 2015; Linzmeier et al., 2018; Hoffmann et al., 2019; Machalski et al., 2021). These studies interpreted several Jurassic and Cretaceous ammonoids as demersal during post-embryonic or adult stages. We could not analyze oxygen isotopes in this study because the preservation of the shell material of most specimens was insufficient for isotopic analyses. However, considering these studies and our morphological data, we hypothesized that the second covariable change in this study indicated the end of the neanic (i.e., planktic) stage (Figs. 4–6; Table 1; Arai and Wani, 2012; Takai et al., 2022).

Linzmeier et al. (2018) analyzed the oxygen isotopes of Late Cretaceous scaphitid specimens from the Fox Hills Formation in South Dakota, USA. They revealed that scaphitids lived in shallow water immediately after hatching and then transitioned to a more demersal mode of life after 270–360° growth from nepionic constriction. At this stage, the conch shape covariably changed (Landman, 1987; Linzmeier et al., 2018). We measured the conch morphology based on the figured photograph (J-273) in Linzmeier et al. (2018) and then reassessed the ontogenetic trajectories of the conch morphology (septal spacing, aperture height, and WER) of this species. The ontogenetic trajectory of septal spacing exhibited a cycle comprising an increase and subsequent decrease in the earliest ontogeny, and an almost flat tendency after that. The aperture height had a steeper slope against the conch diameter, then became gentler and finally steeper. The WER initially decreased and subsequently increased. These ontogenetic trajectory patterns concord with those observed in most of the examined Perisphinctina (except for Collignoniceratidae) and Ancyloceratina (Table 1). These concordances support the interpretation that the covariable morphological change (i.e., the second covariable change in this study) was related to the transition of modes of life from planktic to different habitats (e.g., demersal).

We estimated the conch diameters at the end of the planktic neanic stage as 1.4–3.3 mm for *Yezoites puerculus* and 1.1 mm for *Hoploscaphites comprimus* (Owen, 1852) (Table 1). Assuming that the growth rates during the early growth stages of these two scaphitids are comparable, *Yezoites puerculus* would have experienced a longer duration of planktic dispersal than *Hoploscaphites comprimus*. The longer duration of planktic dispersal explains the wider geographical range. The geographical distribution of *Yezoites puerculus* is known to be distributed in the circum-North Pacific region (Tanabe, 2022). In addition, the distribution of *Hoploscaphites comprimus* is limited to South Dakota and North Dakota, USA (Owen, 1852; Machalski et al., 2007; Linzmeier et al., 2018). These geographical ranges might validate our hypotheses.

Hoffmann et al. (2019) examined oxygen isotopes of Early Cretaceous ammonoids (Perisphinctina and Lytoceratina) from the Mahajanga Basin, Madagascar. They analyzed specimens of *Cleoniceras* sp., the same genus examined in this study. They measured the oxygen isotopes of specimens > 1 cm in conch diameter and suggested a demersal mode of life. Because there are no isotopic data of < 1 cm conch diameter, the modes

of life just after hatching and during the neanic stages and their transition into the subsequent demersal mode of life were not detected in Hoffmann et al. (2019). Our estimations that individuals of *Cleoniceras* sp. ended their planktic neanic stage at 1.8–2.7 mm in conch diameter (Fig. 4.7–4.9; Table 1) does not contradict the results reported by Hoffmann et al. (2019).

Based on our results alone, we do not intend to specify the detailed mode of life after the end of the planktic neanic stage. Individuals of the examined species could be demersal thereafter; however, we did not define the details of the demersal mode of life, such as permanent bottom dwellers or bottom dwellers with diurnal, seasonal, annual, or biennial migrations (Moriya, 2015a). However, the common conch shape during early ontogeny between most of the examined species of Perisphinctina and Ancyloceratina implied similar paleoecology until the end of the neanic stage.

The family Collignoniceratidae did not fall under the category of common ontogenetic trajectories of conch shape between Perisphinctina and Ancyloceratina. The Collignoniceratidae may have a peculiar paleoecology.

Acknowledgments

We are grateful to K. Ayyasami, S. Anantharaman, D. Aiba, and T. Iwasaki for their cooperation during fieldwork and fossil sampling. This study is based on a presentation at the 11th International Symposium on Cephalopods Present & Past in London. We thank Z. Hughes for organizing the symposium. We sincerely thank K. De Baets and an anonymous reviewer, as well as the editors (O. Vinn and M.M. Yacobucci) for their valuable and thoughtful comments on an earlier draft of this manuscript. This study was supported by the Grants-in-Aid for Scientific Research (No. 22K03794) to RW.

Author contributions

All authors conceived and designed this study, collected the data, analyzed the dataset, wrote and discussed the content of the manuscript, and approved the final submission for publication.

Declaration of competing interests

The authors declare none.

Data availability statement

Data available from the Dryad Digital Repository: <https://doi.org/10.5061/dryad.bzkh189p>.

References

- Arai, K., and Wani, R., 2012, Variable growth modes in Late Cretaceous ammonoids: implications for diverse early life histories: *Journal of Paleontology*, v. 86, p. 258–267.
- Arkell, W.J., Furnish, W.M., Kummel, B., Miller, A.K., Moore, R.C., Schindewolf, O.H., Sylvester-Bradley, P.C., and Wright, C.W., 1957, *Treatise on Invertebrate Paleontology. Part. L. Mollusca 4, Cephalopoda Ammonoidea*: Boulder, Colorado and Lawrence, Kansas, Geological Society of America and University of Kansas Press, 490 p.

- Ayyasami, K., 2006, Role of oysters in biostratigraphy: a case study from the Cretaceous of the Ariyalur area, southern India: *Geosciences Journal*, v. 10, p. 237–247.
- Besairie, H., 1972, Géologie de Madagascar. I. Les Terrains sédimentaires: *Annales Géologiques de Madagascar*, v. 35, 465 p.
- Besse, J., and Courtillot, V., 1988, Paleogeographic maps of the continents bordering the Indian Ocean since the Early Jurassic: *Journal of Geophysical Research*, v. 93, p. 11791–11808.
- Bessenova, N.V., and Mikhailova, I.A., 1991, Higher taxa of Jurassic and Cretaceous Ammonitida: *Paleontological Journal*, v. 25, p. 1–19.
- Blanford, H.F., 1862, On the Cretaceous and other rocks of the South Arcot and Trichinopoly districts, Madras: *Memoirs of the Geological Survey of India*, v. 4, p. 1–217.
- Breistroffer, M., 1933, Etude sur l'étage Albien dans le massif de la Chartreuse (Isère et Savoie): *Travaux du Laboratoire de Géologie de l'Université de Grenoble*, v. 17, p. 187–236.
- Bucher, H., Landman, N.H., Guex, J., and Klofak, S.M., 1996, Mode and rate of growth in ammonoids, in Landman, N.H., Tanabe, K., and Davis, R.A., eds., *Ammonoid Paleobiology*: New York, Plenum Press, p. 407–461.
- Callomon, J.H., 1955, The ammonite succession in the Lower Oxford Clay and Kellaway beds at Kidlington, Oxfordshire, and the zones of the Callovian Stage: *Philosophical Transactions of the Royal Society of London. Series B, Biological Sciences*, v. 239, p. 215–264.
- Callomon, J.H., 1963, Sexual dimorphism in Jurassic ammonites: *Transactions of the Leicester Literary and Philosophical Society*, v. 57, p. 21–56.
- Checa, A., and Sandoval, J., 1989, Septal retraction in Jurassic Ammonitina: *Neues Jahrbuch für Geologie und Paläontologie, Monatshefte*, v. 4, p. 193–211.
- Collignon, M., 1949, Recherches sur les faunes Albiennes de Madagascar. I. l'Albien d'Ambarimanina: *Annales Géologiques de Service des Mines*, v. 16, p. 1–128.
- Collignon, M., 1963, Atlas des Fossiles Caractéristiques de Madagascar (Ammonites), Fascicule X (Albien): Antananarivo, Madagascar, Service Géologique, 186 p.
- Crick, R.E., 1978, Morphological variations in the ammonite *Scaphites* of the Blue Hill Member, Carlisle Shale, Upper Cretaceous, Kansas: *University of Kansas Paleontological Contributions*, v. 88, p. 1–28.
- Davis, R.A., Landman, N.H., Dommergues, J.-L., Marchand, D., and Bucher, H., 1996, Mature modifications and dimorphism in ammonoid cephalopods, in Landman, N.H., Tanabe, K., and Davis, R.A., eds., *Ammonoid Paleobiology*: New York, Plenum Press, p. 463–539.
- De Baets, K., Klug, C., Korn, D., and Landman, N.H., 2012, Early evolutionary trends in ammonoid embryonic development: *Evolution*, v. 66, p. 1788–1806.
- De Baets, K., Klug, C., Korn, D., Bartels, C., and Poschmann M., 2013, Emsian Ammonoidea and the age of the Hunsrück Slate (Rhenish Mountains, western Germany): *Palaeontographica A*, v. 299, p. 1–113.
- De Baets, K., Landman, N.H., and Tanabe, K., 2015a, Ammonoid embryonic development, in Klug, C., Korn, D., De Baets, K., Kruta, I., and Mapes, R.H., eds., *Ammonoid Paleobiology: From Anatomy to Ecology*: Amsterdam, Springer, p. 113–205.
- De Baets, K., Bert, D., Hoffmann, R., Monnet, C., Yacobucci, M.M., and Klug, C., 2015b, Ammonoid intraspecific variability, in Klug, C., Korn, D., De Baets, K., Kruta, I., and Mapes, R.H., eds., *Ammonoid Paleobiology: From Anatomy to Ecology*: Amsterdam, Springer, p. 259–426.
- Donovan, D.T., Callomon, J.H., and Howarth, M.K., 1981, Classification of the Jurassic Ammonitina, in House, M.R., and Senior, J.R., eds., *The Ammonoidea: The Evolution, Classification, Mode of Life, and Geological Usefulness of a Major Fossil Group*: Systematics Association Special Volume 18, p. 101–155.
- Drushchits, V.V., and Khiami, N., 1970, Structure of the septa, protoconch walls and initial whorls in Early Cretaceous ammonites: *Paleontological Journal*, v. 4, p. 26–38.
- Drushchits, V.V., Doguzhayeva, L.A., and Mikhaylova, I.A., 1977, The structure of the ammonitella and the direct development of ammonites: *Paleontological Journal*, v. 11, p. 188–199.
- Harada, K., and Tanabe, K., 2005, Paedomorphosis in the Turonian (Late Cretaceous) collignoniceratid ammonite lineage from the North Pacific region: *Lethaia*, v. 38, p. 47–57.
- Hayami, I., and Matsukuma, A., 1970, Variation of bivariate characters from the standpoint of allometry: *Palaeontology*, v. 13, p. 588–605.
- Hayasaka, I., and Fukada, A., 1951, On the ontogeny of *Barroisiceras minimum* Yabe from the upper ammonite bed in Hokkaido: *Journal of the Faculty of Science, Hokkaido University*, v. 7, p. 324–330.
- Hoffmann, R., Lemanis, R., Naglik, C., and Klug, C., 2015, Ammonoid buoyancy, in Klug, C., Korn, D., De Baets, K., Kruta, I., and Mapes, R.H., eds., *Ammonoid Paleobiology: From Anatomy to Ecology*: Amsterdam, Springer, p. 613–648.
- Hoffmann, R., Lemanis, R.E., Falkenberg, J., Schneider, S., Wesendonk, H., and Zachow, S., 2018, Integrating 2D and 3D shell morphology to disentangle the palaeobiology of ammonoids: a virtual approach: *Palaeontology*, v. 61, p. 89–104.
- Hoffmann, R., Riechelmann, S., Ritterbush, K.A., Koelen, J., Lübke, N., Joachimski, M.M., Lehmann, J., and Immenhauser, A., 2019, A novel multi-proxy approach to reconstruct the palaeoecology of extinct cephalopods: *Gondwana Research*, v. 67, p. 64–81.
- Hoffmann, R., Slattery, J.S., Kruta, I., Linzmeier, B.J., Lemanis, R.E., Mironenko, A., Goolaerts, S., De Baets, K., Peterman, D.J., and Klug, C., 2021, Recent advances in heteromorph ammonoid palaeobiology: *Biological Reviews*, v. 96, p. 576–610.
- Iwasaki, T., Iwasaki, Y., and Wani, R., 2020, Polymorphism in Late Cretaceous phylloceratid ammonoids: evidence from ontogenetic trajectories of septal spacing: *Papers in Palaeontology*, v. 6, p. 155–172.
- Jacob, C., 1907, Etudes paléontologiques et stratigraphiques sur la partie moyenne des terrains Crétacés dans les Alpes Françaises et les régions voisines: *Annales de l'Université de Grenoble*, v. 19, p. 221–534.
- Jacobs, D.K., and Chamberlain, J.A., Jr., 1996, Buoyancy and hydrodynamics in ammonoids, in Landman, N.H., Tanabe, K., and Davis, R.A., eds., *Ammonoid Paleobiology*: New York, Plenum Press, p. 169–224.
- Jimbo, K., 1894, Beiträge zur Kenntnis der fauna der Kreideformation von Hokkaido: *Palaeontologische Abhandlungen (n. ser.)*, v. 2 [3], p. 1–48 [p. 147–194].
- Kawakami, Y., and Wani, R., 2023, Stepwise growth changes in early post-embryonic stages among Cretaceous tetragonitid ammonoids: *Paläontologische Zeitschrift*, v. 97, p. 469–483.
- Kawakami, Y., Uchida, N., and Wani, R., 2022, Ontogenetic trajectories of septal spacing and conch shape in the Late Cretaceous gaudryceratid ammonoids: implications for their post-embryonic palaeoecology: *Palaeontology*, v. 65, e12587, <https://doi.org/10.1111/pala.12587>.
- Kermack, K.A., and Haldane, J.B.S., 1950, Organic correlation and allometry: *Biometrika*, v. 37, p. 30–41.
- Klug, C., 2001, Life-cycles of Emsian and Eifelian ammonoids (Devonian): *Lethaia*, v. 34, p. 215–233.
- Klug, C., 2004, Mature modifications, the black band, the black aperture, the black stripe, and the periostracum in cephalopods from the Upper Muschelkalk (Middle Triassic, Germany): *Mitteilungen aus dem Geologisch-Paläontologischen Institut der Universität Hamburg*, v. 88, p. 63–78.
- Klug, C., and Hoffmann, R., 2015, Ammonoid septa and sutures, in Klug, C., Korn, D., De Baets, K., Kruta, I., and Mapes, R.H., eds., *Ammonoid Paleobiology: From Anatomy to Ecology*: Amsterdam, Springer, p. 45–90.
- Klug, C., Brühwiler, T., Korn, D., Schweigert, G., Brayard, A., and Tilsley, J., 2007, Ammonoid shell structures of primary organic composition: *Palaeontology*, v. 50, p. 1463–1478.
- Klug, C., Korn, D., Landman, N.H., Tanabe, K., De Baets, K., and Naglik, C., 2015, Describing ammonoid conchs, in Klug, C., Korn, D., De Baets, K., Kruta, I., and Mapes, R.H., eds., *Ammonoid Paleobiology: From Anatomy to Ecology*: Amsterdam, Springer, p. 3–24.
- Kossmat, F., 1895–1898, Untersuchungen über die Süindische Kreideformation: *Beiträge zur Paläontologie Österreich-Ungarns und des Orients*, v. 9, p. 97–203; v. 11, p. 1–46, 89–152.
- Kulicki, C., 1974, Remarks on the embryogeny and postembryonic development of ammonites: *Acta Palaeontologica Polonica*, v. 19, p. 201–224.
- Kulicki, C., 1979, The ammonite shell: its structure, development and biological significance: *Palaeontologica Polonica*, v. 39, p. 97–142.
- Kulicki, C., 1996, Ammonoid shell microstructure, in Landman, N.H., Tanabe, K., and Davis, R.A., eds., *Ammonoid Paleobiology*: New York, Plenum Press, p. 65–101.
- Landman, N.H., 1985, Preserved ammonitellas of *Scaphites* (Ammonoidea, Ancyloceratina): *American Museum Novitates*, v. 2815, p. 1–10.
- Landman, N.H., 1987, Ontogeny of Upper Cretaceous (Turonian–Santonian) scaphitid ammonites from the Western Interior of North America: systematics, developmental patterns and life history: *Bulletin of American Museum of Natural History*, v. 185, p. 118–241.
- Landman, N.H., 1988, Early ontogeny of Mesozoic ammonites and nautilids, in Wiedmann, J., and Kullmann, J., eds., *Cephalopods, Present and Past*: Stuttgart, Germany, Schweizerbart'sche Verlagsbuchhandlung, p. 215–228.
- Landman, N.H., and Waage, K.H., 1993, Scaphitid ammonites of the Upper Cretaceous (Maastrichtian) Fox Hills Formation in South Dakota and Wyoming: *Bulletin of the American Museum of Natural History*, v. 215, p. 1–257.
- Landman, N.H., Tanabe, K., and Shigeta, Y., 1996, Ammonoid embryonic development, in Landman, N.H., Tanabe, K., and Davis, R.A., eds., *Ammonoid Paleobiology*: New York, Plenum Press, p. 343–405.
- Landman, N.H., Machalski, M., and Whalen, C.D., 2021, The concept of 'heteromorph ammonoids': *Lethaia*, v. 54, p. 595–602, <https://doi.org/10.1111/let.12443>.
- Lécuyer, C., and Bucher, H., 2006, Stable isotope compositions of a Late Jurassic ammonite shell: a record of seasonal surface water temperatures in the southern hemisphere?: *eEarth*, v. 1, <https://doi.org/10.5194/ee-1-1-2006>.

- Lehmann, J., 2015, Ammonite biostratigraphy of the Cretaceous—an overview, *in* Klug, C., Korn, D., De Baets, K., Kruta, I., and Mapes, R.H., eds., *Ammonoid Paleobiology: From Macroevolution to Paleogeography*: Amsterdam, Springer, p. 403–429.
- Lemanis, R., Korn, D., Zachow, S., Rybacki, E., and Hoffmann, R., 2016, The evolution and development of cephalopod chambers and their shape: *PLoS ONE*, v. 11, p. e0151404, <https://doi.org/10.1371/journal.pone.0151404>.
- Lemanis, R., Zachow, S., Fusses, F., and Hoffmann, R., 2015, A new approach using high-resolution computed tomography to test the buoyant properties of chambered cephalopod shells: *Paleobiology*, v. 41, p. 313–329.
- Linzmeier, B.J., Landman, N.H., Peters, S.E., Kozdon, R., Kitajima, K., and Valley, J.W., 2018, Ion microprobe-measured stable isotope evidence for ammonite habitat and life mode during early ontogeny: *Paleobiology*, v. 44, p. 684–708.
- Lukeneder, A., 2015, Ammonoid habitats and life history, *in* Klug, C., Korn, D., De Baets, K., Kruta, I., and Mapes, R.H., eds., *Ammonoid Paleobiology: From Anatomy to Ecology*: Amsterdam, Springer, p. 689–791.
- Lukeneder, A., Harzhauser, M., Müllegger, S., and Piller, W.E., 2010, Ontogeny and habitat change in Mesozoic cephalopods revealed by stable isotopes ($\delta^{18}\text{O}$, $\delta^{13}\text{C}$): *Earth and Planetary Science Letters*, v. 296, p. 103–114.
- Machalski, M., Jagt, J.W.M., Landman, N.H., and Motchurova-Dekova, N., 2007, The highest records of North American scaphitid ammonites in the European Maastrichtian (Upper Cretaceous) and their stratigraphic implications: *Acta Geologica Polonica*, v. 57, p. 169–185.
- Machalski, M., Owoc, K., Dubicka, Z., Malchuk, O., and Wierny, W., 2021, Stable isotopes and predation marks shed new light on ammonoid habitat depth preferences: *Scientific Reports*, v. 11, 22730, <https://doi.org/10.1038/s41598-021-02236-9>.
- Mapes, R.H., and Nützel, A., 2009, Late Palaeozoic mollusc reproduction: cephalopod egg-laying behavior and gastropod larval palaeobiology: *Lethaia*, v. 42, p. 341–356.
- Matsumoto, T., 1942, A note on the Japanese Cretaceous ammonites belonging to the subfamily Desmoceratinae: *Proceedings of the Imperial Academy of Japan*, v. 18, p. 24–29.
- Matsumoto, T., 1954, Selected Cretaceous leading ammonites in Hokkaido and Saghalin, *in* Matsumoto, T., ed., *Cretaceous System in the Japanese Islands*: Tokyo, The Japanese Society for the Promotion of Science, v. 14, p. 242–313.
- Mignot, Y., 1993, Un problème de paléobiologie chez les ammonoïdés (Céphalopoda). Croissance et miniaturisation en liaison avec les environnements: *Documents des Laboratoires de Géologie, Lyon*, v. 124, p. 1–113.
- Mikhailova, I.A., and Baraboshkin, E.Y., 2009, The evolution of the heteromorph and monomorph Early Cretaceous ammonites of the suborder Ancyloceratina Wiedmann: *Paleontological Journal*, v. 43, p. 527–536.
- Moriya, K., 2015a, Isotope signature of ammonoid shells, *in* Klug, C., Korn, D., De Baets, K., Kruta, I., and Mapes, R.H., eds., *Ammonoid Paleobiology: From Anatomy to Ecology*: Amsterdam, Springer, p. 793–836.
- Moriya, K., 2015b, Evolution of habitat depth in the Jurassic–Cretaceous ammonoids: *Proceedings of the National Academy of Sciences*, v. 112, p. 15540–15541, <https://doi.org/10.1073/pnas.1520961112>.
- Moriya, K., Nishi, H., Kawahata, H., Tanabe, K., and Takayanagi, Y., 2003, Demersal habitat of Late Cretaceous ammonoids: evidence from oxygen isotopes for the Campanian (Late Cretaceous) northwestern Pacific thermal structure: *Geology*, v. 31, p. 167–170.
- Naglik, C., Tajika, A., Chamberlain, J., and Klug, C., 2015, Ammonoid locomotion, *in* Klug, C., Korn, D., De Baets, K., Kruta, I., and Mapes, R.H., eds., *Ammonoid Paleobiology: From Anatomy to Ecology*: Amsterdam, Springer, p. 649–688.
- Owen, D.D., 1852, Description of new and imperfectly known genera and species of organic remains, collected during the geological surveys of Wisconsin, Iowa, and Minnesota: Report of a geological survey of Wisconsin, Iowa, and Minnesota; and incidentally of a portion of Nebraska Territory: Philadelphia, Lippincott, Grambo & co, 638 p.
- Page, K.N., 1996, Mesozoic ammonoids in space and time, *in* Landman, N.H., Tanabe, K., and Davis, R.A., eds., *Ammonoid Paleobiology*: New York, Plenum Press, p. 755–794.
- Peterman, D.J., and Barton, C.C., 2019, Power scaling of ammonitic suture patterns from Cretaceous Ancyloceratina: constraints on septal/sutural complexity: *Lethaia*, v. 52, p. 77–90.
- Ritterbush, K.A., Hoffmann, R., Lukeneder, A., and De Baets, K., 2014, Pelagic palaeoecology: the importance of recent constraints on ammonoids palaeobiology and life history: *Journal of Zoology*, v. 292, p. 229–241.
- Rouget, I., and Neige, P., 2001, Embryonic ammonoid shell features: intraspecific variation revised: *Paleontology*, v. 44, p. 53–64.
- Sessa, J.A., Larina, E., Knoll, K., Garb, M., Cochran, J.K., Huber, B.T., Macleod, K.G., and Landman, N.H., 2015, Ammonite habitat revealed via isotopic composition and comparisons with co-occurring benthic and planktonic organisms: *Proceedings of the National Academy of Sciences*, v. 112, p. 15562–15567, <https://doi.org/10.1073/pnas.1507554112>.
- Shigeta, Y., 1993, Post-hatching early life history of Cretaceous Ammonoidea: *Lethaia*, v. 26, p. 133–145.
- Shigeta, Y., Zakharov, Y.D., and Mapes, R.H., 2001, Origin of the Ceratitida (Ammonoidea) inferred from the early internal shell features: *Paleontological Research*, v. 5, p. 201–213.
- Shimizu, S., 1934, (Taxonomy of Phylloceratinae), *in* Shimizu, S., and Obata, T., eds., *Cephalopoda. Iwanami's Lecture Series of Geology & Palaeontology*: Tokyo, Iwanami Shoten, p. 1–137. [in Japanese]
- Sundaram, R., Henderson, R.A., Ayyasami, K., and Stilwekk, J.D., 2001, A lithostratigraphic revision and palaeoenvironmental assessment of the Cretaceous System exposed in the onshore Cauvery Basin, southern India: *Cretaceous Research*, v. 22, p. 743–762.
- Tajika, A., and Klug, C., 2020, How many ontogenetic points are needed to accurately describe the ontogeny of a cephalopod conch? A case study of the modern nautilid *Nautilus pompilius*: *PeerJ*, 8:e8849, <http://doi.org/10.7717/peerj.8849>.
- Tajika, A., and Wani, R., 2011, Intraspecific variation of hatchling size in Late Cretaceous ammonoids from Hokkaido, Japan: implication for planktic duration at early ontogenetic stage: *Lethaia*, v. 44, p. 287–298.
- Tajika, A., Morimoto, N., Wani, R., Naglik, C., and Klug, C., 2015, Intraspecific variation of phragmocone chamber volumes throughout ontogeny in the modern nautilid *Nautilus* and the Jurassic ammonite *Normannites*: *PeerJ*, v. 3, e1306, <https://doi.org/10.7717/peerj.1306>.
- Takai, F., Matsukuma, S., Hirose, K., Yamazaki, T., Aiba, D., and Wani, R., 2022, Conservative ontogenetic trajectories of septal spacing during the post-embryonic stage in Cretaceous ammonoids of the subfamily Desmoceratinae: *Lethaia*, v. 55, p. 1–12, <https://doi.org/10.18261/let.55.2.2>.
- Tanabe, K., 1977, Functional evolution of *Otoscapites puerulus* (Jimbo) and *Scaphites planus* (Yabe), Upper Cretaceous ammonites: *Memoirs of the Faculty of Science, Kyusyu University, Series D, Geology*, v. 23, p. 367–407.
- Tanabe, K., 2022, Late Cretaceous dimorphic scaphitid ammonoid genus *Yezoites* from the circum-North Pacific regions: *Paleontological Research*, v. 26, p. 233–269.
- Tanabe, K., and Ohtsuka, Y., 1985, Ammonoid early internal shell structure: its bearing on early life history: *Paleobiology*, v. 11, p. 310–322.
- Tanabe, K., Obata, I., and Futakami, M., 1978, Analysis of ammonoid assemblages in the upper Turonian of the Manji Area, central Hokkaido: *Bulletin of the National Science Museum, Series C, Geology & Paleontology*, v. 4, p. 37–62.
- Tanabe, K., Fukuda, Y., and Obata, I., 1980, Ontogenetic development and functional morphology in the early growth stages of three Cretaceous ammonites: *Bulletin of National Science Museum, Series C*, v. 6, p. 9–26.
- Tanabe, K., Landman, N.H., Mapes, R.H., and Faulkner, C.J., 1993, Analysis of a Carboniferous embryonic ammonoid assemblage from Kansas, U.S.A.—implications for ammonoid embryology: *Lethaia*, v. 26, p. 215–224.
- Tanabe, K., Kulicki, C., Landman, N.H., and Mapes, R.H., 2001, External shell features of embryonic and early postembryonic shells of a Carboniferous goniatite *Vidrioceras* from Kansas: *Paleontological Research*, v. 5, p. 13–19.
- Tanabe, K., Landman, N.H., and Yoshioka, Y., 2003, Intra- and interspecific variation in the early internal shell features of some Cretaceous ammonoids: *Journal of Paleontology*, v. 77, p. 876–887.
- Westermann, G.E.G., 1958, The significance of septa and sutures in Jurassic ammonite systematics: *Geological Magazine*, v. 95, p. 441–455.
- Westermann, G.E.G., 1996, Ammonoid life and habitat, *in* Landman, N.H., Tanabe, K., and Davis, R.A., eds., *Ammonoid Paleobiology*: New York, Plenum Press, p. 607–707.
- Wiedmann, J., 1966, Stammesgeschichte und System der posttriadischen Ammonoideen: *Neues Jahrbuch für Geologie und Paläontologie, Abhandlungen*, v. 125, p. 49–79.
- Wiedmann, J., 1969, The heteromorphs and ammonoid extinction: *Biological Reviews*, v. 44, p. 563–602.
- Wright, C.W., Callomon, J.H., and Howarth, M.K., 1996, *Treatise on Invertebrate Paleontology. Part. L. Mollusca 4. Revised*: Lawrence, Kansas, Geological Society of America and University of Kansas Press, 362 p.
- Yabe, H., 1910, Die Scaphiten aus der Oberkreide von Hokkaido: *Beiträge zur Paläontologie Österreich–Ungarns und des Orients*, v. 23, p. 159–174.
- Yacobucci, M.M., 2015, Macroevolution and paleobiogeography of Jurassic–Cretaceous ammonoids, *in* Klug, C., Korn, D., De Baets, K., Kruta, I., and Mapes, R.H., eds., *Ammonoid Paleobiology: From Macroevolution to Paleogeography*: Amsterdam, Springer, p. 189–228.
- Yahada, H., and Wani, R., 2013, Limited migration of scaphitid ammonoids: evidence from the analyses of shell whorls: *Journal of Paleontology*, v. 87, p. 406–412.
- Zell, H., Zell, I., and Winter, S., 1979, Das Gehäusewachstum der Ammonitengattung *Amaltheus* De Montfort während der frühontogenetischen Entwicklung: *Neues Jahrbuch für Geologie und Paläontologie, Monatshefte*, v. 10, p. 631–640.